

High Luminous Efficacy Green LED Emitter

LZ1-00G102

Key Features

- High Luminous Efficacy Green LED emitter
- Ultra-small foot print – 4.4mm x 4.4mm
- Up to 1.5A drive current
- Surface mount ceramic package with integrated glass lens
- Low Thermal Resistance (6.0°C/W)
- Electrically neutral thermal path
- JEDEC Level 1 for Moisture Sensitivity Level
- Lead (Pb) free and RoHS compliant
- Reflow solderable
- Available on tape and reel or with MCPCB

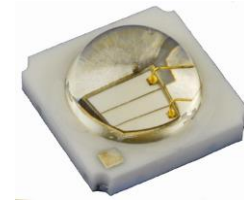

Typical Applications

- Indoor and outdoor Architectural Lighting
- Display Backlighting
- Full Color Displays
- Projectors
- Horticulture

Description

The LZ1-00G102 Green LED emitter generates 215 lumen at 3.7W power dissipation in an extremely small package. With a 4.4mm x 4.4mm footprint, this package provides exceptional luminous flux density. The patent-pending design has unparalleled thermal and optical performance and excellent UV resistance. The high quality materials used in the package are chosen to optimize light output and minimize stresses which results in monumental reliability and lumen maintenance. The robust product design thrives in outdoor applications with high ambient temperatures and high humidity.

Part number options

Base part number

Part number	Description
LZ1-00G102-xxxx	LZ1 emitter
LZ1-10G102-xxxx	LZ1 emitter on Standard Star MCPCB

Bin kit option codes

G1, Green (525nm)			
Kit number suffix	Min flux Bin	Color Bin Range	Description
0000	N	G2 – G4	Flux bin N and above; full distribution wavelength
0G23	N	G2 – G3	Flux bin N and above; wavelength G2 and G3 bins

Notes:

1. Default bin kit option is -0000

Luminous Flux Bins

Table 1:

Bin Code	Minimum Luminous Flux (Φ_v) @ $I_F = 1000\text{mA}$ ^[1] (lm)	Maximum Luminous Flux (Φ_v) @ $I_F = 1000\text{mA}$ ^[1] (lm)
N	145	182
P	182	228
Q	228	285

Notes for Table 1:

- Luminous flux performance is measured at 10ms pulse, $T_c = 25^\circ\text{C}$. LED Engin maintains a tolerance of $\pm 10\%$ on flux measurements.

Dominant Wavelength Bins

Table 2:

Bin Code	Minimum Dominant Wavelength (λ_D) @ $I_F = 1000\text{mA}$ ^[1] (nm)	Maximum Dominant Wavelength (λ_D) @ $I_F = 1000\text{mA}$ ^[1] (nm)
G2	520	525
G3	525	530
G4	530	535

Notes for Table 2:

- Dominant wavelength is measured at 10ms pulse, $T_c = 25^\circ\text{C}$. LED Engin maintains a tolerance of $\pm 1.0\text{nm}$ on dominant wavelength measurements.

Forward Voltage Bins

Table 3:

Bin Code	Minimum Forward Voltage (V_F) @ $I_F = 1000\text{mA}$ ^[1] (V)	Maximum Forward Voltage (V_F) @ $I_F = 1000\text{mA}$ ^[1] (V)
J	3.2	4.2

Notes for Table 3:

- Forward voltage is measured at 10ms pulse, $T_c = 25^\circ\text{C}$. LED Engin maintains a tolerance of $\pm 0.04\text{V}$ for forward voltage measurements.

Absolute Maximum Ratings

Table 4:

Parameter	Symbol	Value	Unit
DC Forward Current at $T_{J(MAX)}=90^{\circ}\text{C}^{[1]}$	I_F	1500	mA
DC Forward Current at $T_{J(MAX)}=135^{\circ}\text{C}^{[1]}$	I_F	1200	mA
DC Forward Current at $T_{J(MAX)}=150^{\circ}\text{C}^{[1]}$	I_F	1000	mA
Peak Pulsed Forward Current ^[2]	I_{FP}	2000	mA
Reverse Voltage	V_R	See Note 3	V
Storage Temperature	T_{stg}	-40 ~ +150	$^{\circ}\text{C}$
Junction Temperature	T_J	150	$^{\circ}\text{C}$
Soldering Temperature ^[4]	T_{sol}	260	$^{\circ}\text{C}$

Notes for Table 4:

1. Maximum DC forward current is determined by the overall thermal resistance and ambient temperature. Follow the curves in Figure 11 for current derating.
2. Pulse forward current conditions: Pulse Width $\leq 10\text{msec}$ and Duty cycle $\leq 10\%$.
3. LEDs are not designed to be reverse biased.
4. Solder conditions per JEDEC J-STD-020. See Reflow Soldering Profile Figure 3.
5. LED Engin recommends taking reasonable precautions towards possible ESD damages and handling the LZ1-00G102 in an electrostatic protected area (EPA). An EPA may be adequately protected by ESD controls as outlined in ANSI/ESD S6.1.

Optical Characteristics @ $T_C = 25^{\circ}\text{C}$

Table 5:

Parameter	Symbol	Typical	Unit
Luminous Flux (@ $I_F = 1000\text{mA}/1200\text{mA}/1500\text{mA}$)	Φ_V	215/ 235/ 270	lm
Radiant Flux (@ $I_F = 1000\text{mA}/1200\text{mA}/1500\text{mA}$)	Φ	450/ 490/ 560	mW
PPF ^[1] 400-700nm (@ $I_F = 1000\text{mA}/1200\text{mA}/1500\text{mA}$)		2.0/ 2.1/ 2.4	umol/s
Dominant Wavelength (@ $I_F = 700\text{mA}$)	λ_D	523	nm
Peak Wavelength (@ $I_F = 700\text{mA}$)	λ_P	517	nm
Viewing Angle ^[2]	$2\Theta_{1/2}$	100	Degrees
Total Included Angle ^[3]	$\Theta_{0.9}$	120	Degrees

Notes for Table 5:

1. PPF is Photosynthetic Photon Flux.
2. Viewing Angle is the off axis angle from emitter centerline where the luminous intensity is $\frac{1}{2}$ of the peak value.
3. Total Included Angle is the total angle that includes 90% of the total luminous flux.

Electrical Characteristics @ $T_C = 25^{\circ}\text{C}$

Table 6:

Parameter	Symbol	Typical	Unit
Forward Voltage (@ $I_F = 1000\text{mA}$)	V_F	3.75	V
Forward Voltage (@ $I_F = 1200\text{mA}$)	V_F	3.85	V
Forward Voltage (@ $I_F = 1500\text{mA}$)	V_F	3.95	V
Temperature Coefficient of Forward Voltage	$\Delta V_F/\Delta T_J$	-4.0	mV/ $^{\circ}\text{C}$
Thermal Resistance (Junction to Case)	$R\Theta_{J-C}$	6.0	$^{\circ}\text{C}/\text{W}$

IPC/JEDEC Moisture Sensitivity Level

Table 7 - IPC/JEDEC J-STD-020 MSL Classification:

Level	Floor Life		Soak Requirements			
	Time	Conditions	Standard	Accelerated	Standard	Accelerated
	Time	Conditions	Time (hrs)	Conditions	Time (hrs)	Conditions
1	Unlimited	≤ 30°C/ 85% RH	168 +5/-0	85°C/ 85% RH	n/a	n/a

Notes for Table 7:

- The standard soak time includes a default value of 24 hours for semiconductor manufacturer's exposure time (MET) between bake and bag and includes the maximum time allowed out of the bag at the distributor's facility.

Average Lumen Maintenance Projections

Lumen maintenance generally describes the ability of a lamp to retain its output over time. The useful lifetime for solid state lighting devices (Power LEDs) is also defined as Lumen Maintenance, with the percentage of the original light output remaining at a defined time period.

Based on long-term WHTOL testing, LED Engin projects that the LZ Series will deliver, on average, above 70% Lumen Maintenance at 50,000 hours of operation at a forward current of 1000 mA. This projection is based on constant current operation with junction temperature maintained at or below 125°C.

Recommended Solder Mask Layout (mm)

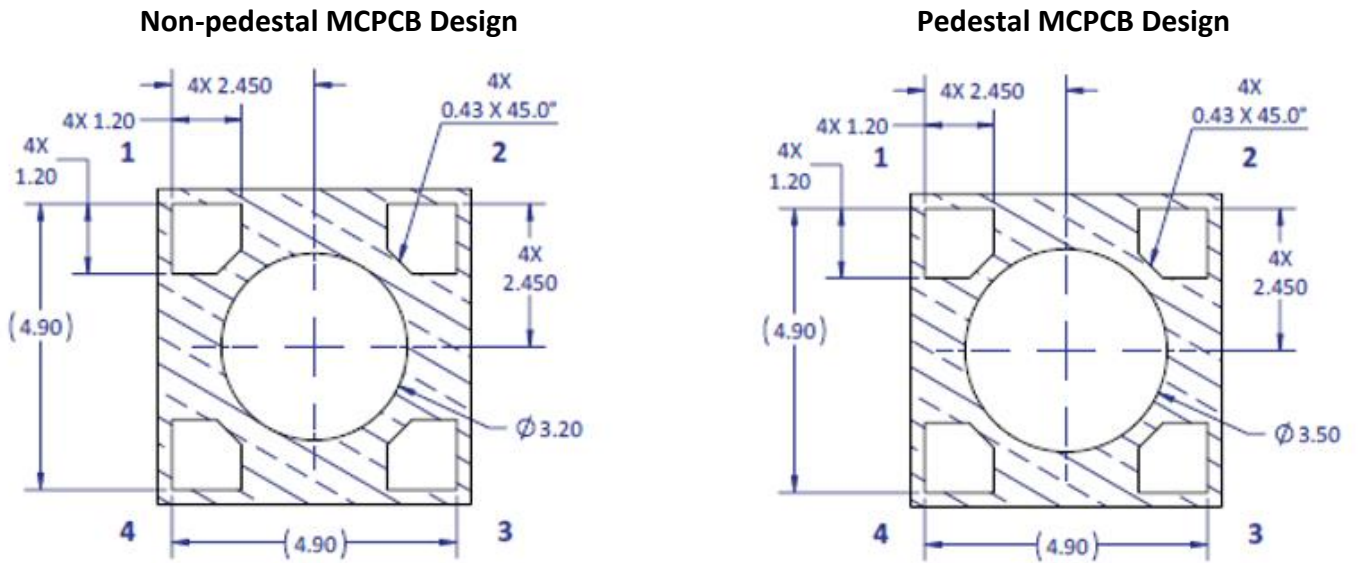

Figure 2b: Recommended solder mask opening for anode, cathode, and thermal pad for non-pedestal and pedestal design

Note for Figure 2b:

1. Unless otherwise noted, the tolerance = ± 0.20 mm.

Recommended 8mil Stencil Apertures Layout (mm)

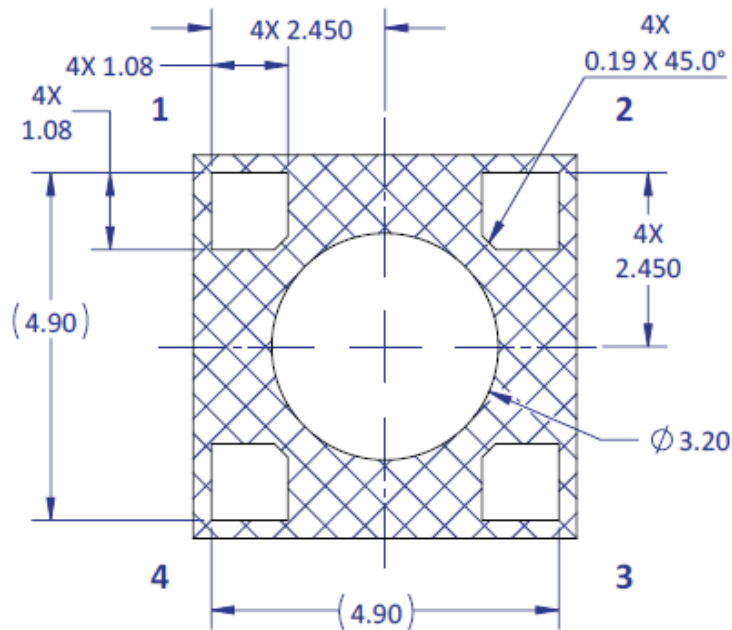

Figure 2c: Recommended 8mil stencil apertures layout for anode, cathode, and thermal pad.

Note for Figure 2c:

1. Unless otherwise noted, the tolerance = ± 0.20 mm.

Reflow Soldering Profile

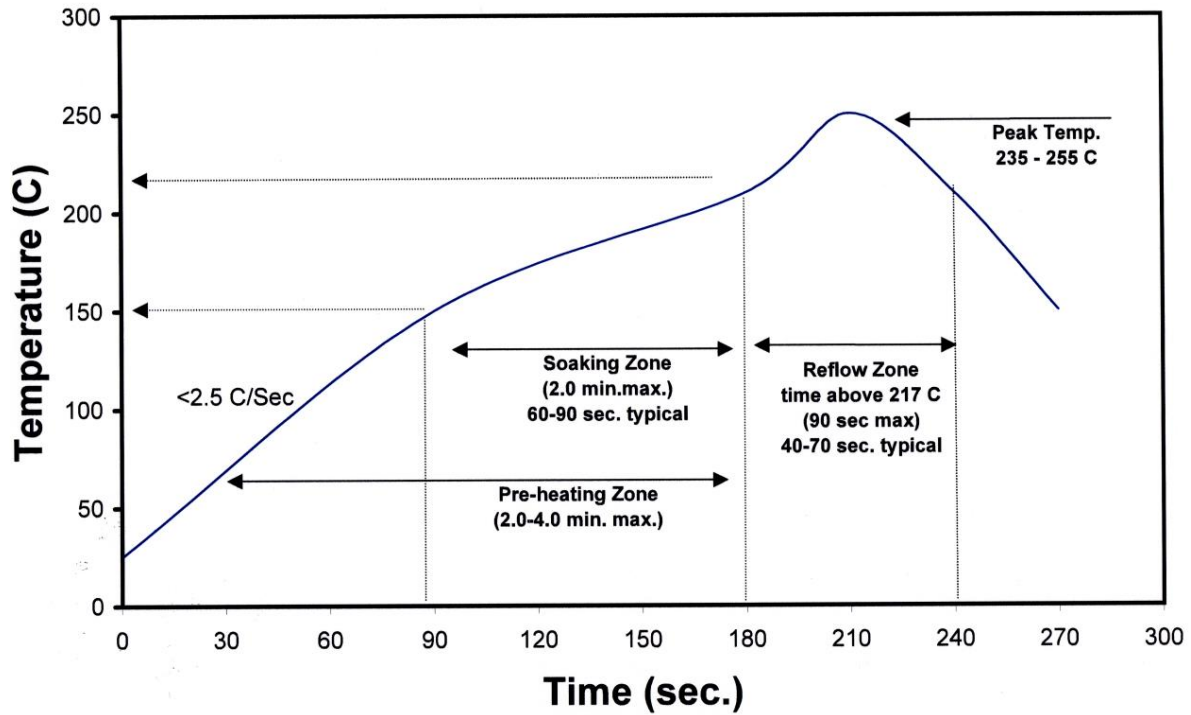

Figure 3: Reflow soldering profile for lead free soldering.

Typical Radiation Pattern

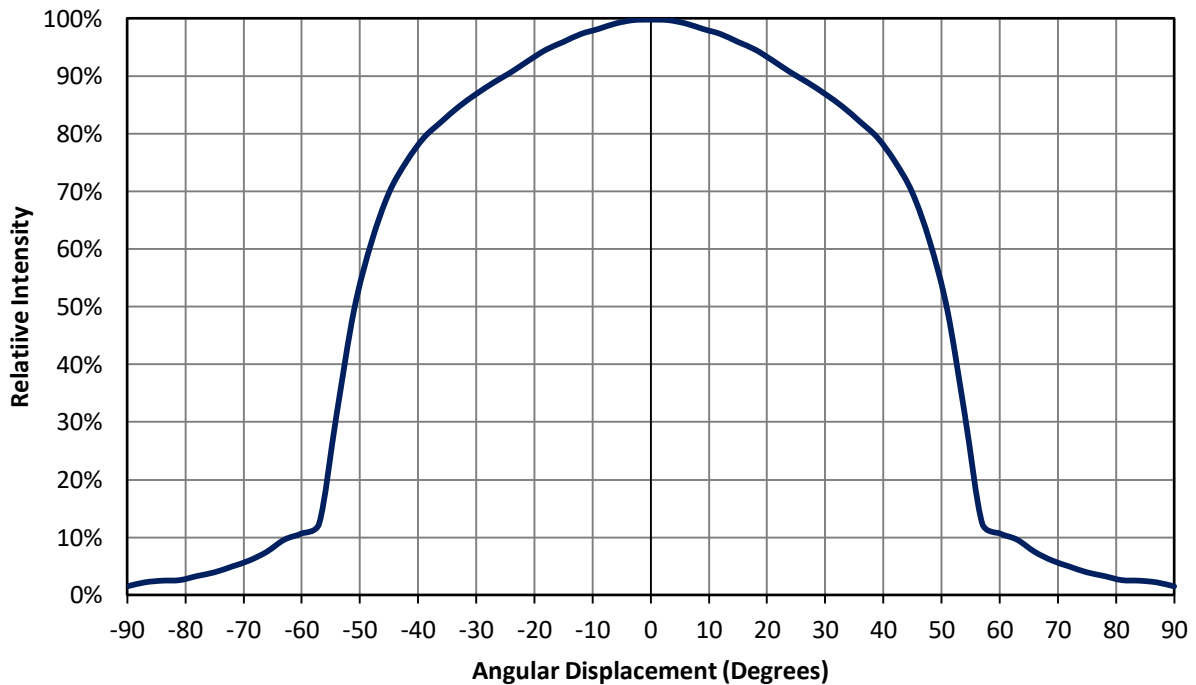

Figure 4: Typical representative spatial radiation pattern @ $T_c = 25^\circ\text{C}$.

Typical Relative Spectral Power Distribution

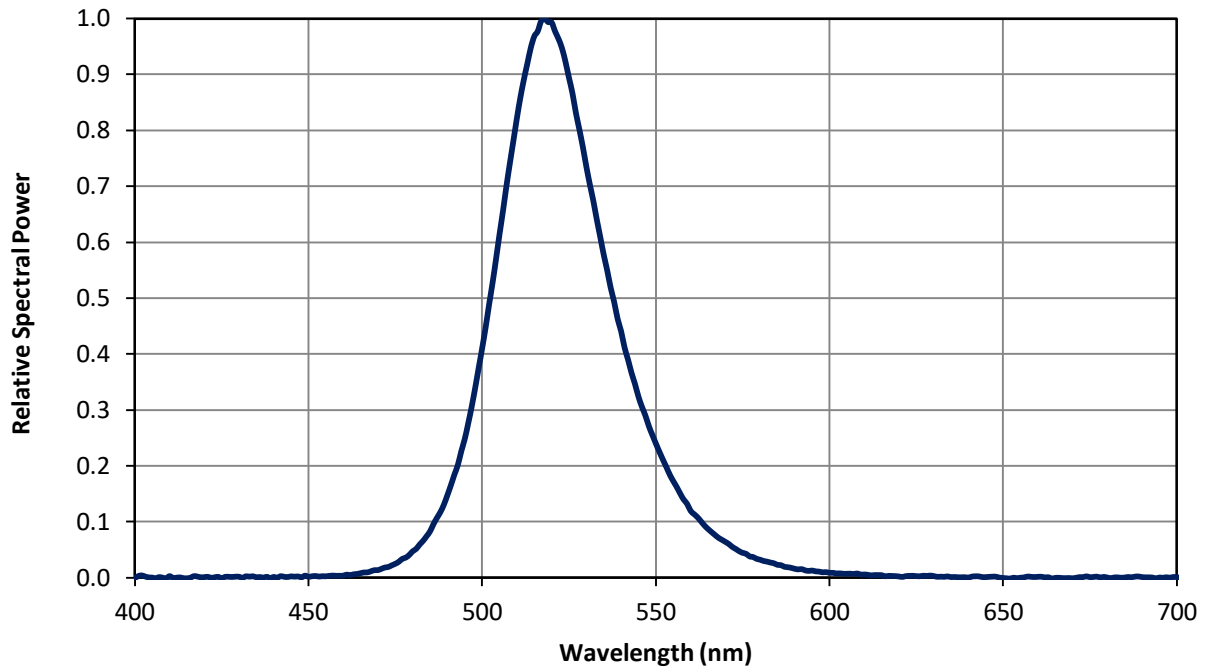

Figure 5: Relative spectral power vs. wavelength @ $T_c = 25^\circ\text{C}$.

Typical Forward Current Characteristics

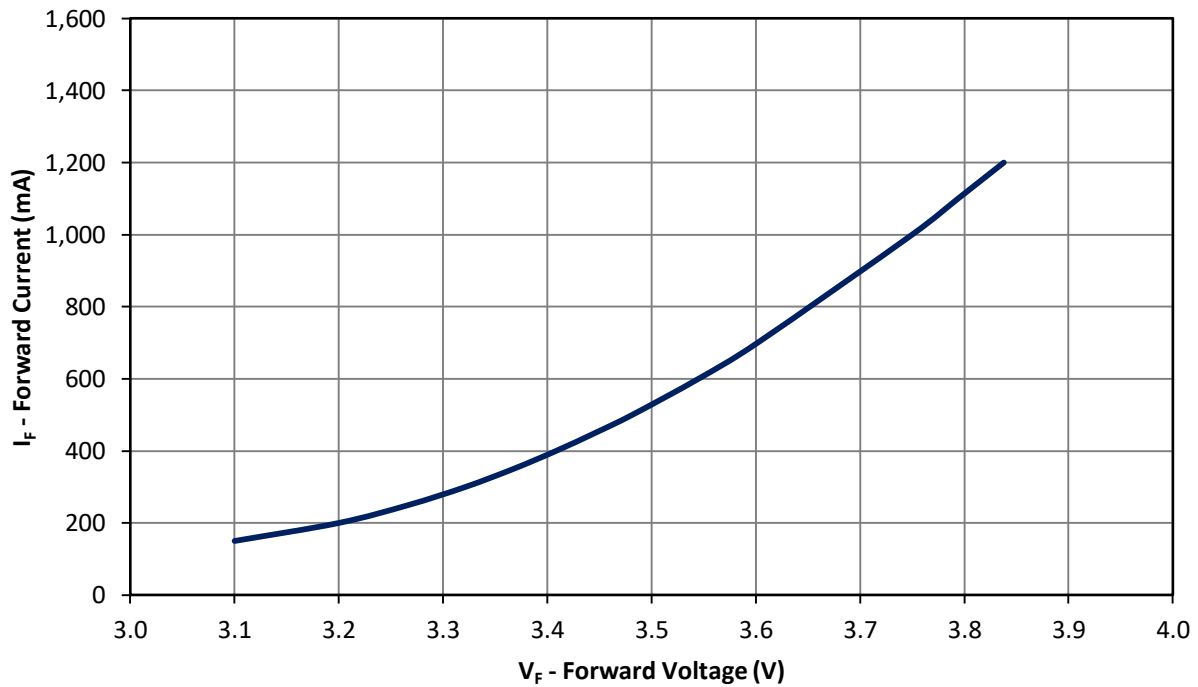

Figure 6: Typical forward current vs. forward voltage @ $T_c = 25^\circ\text{C}$.

Typical Relative Light Output over Current

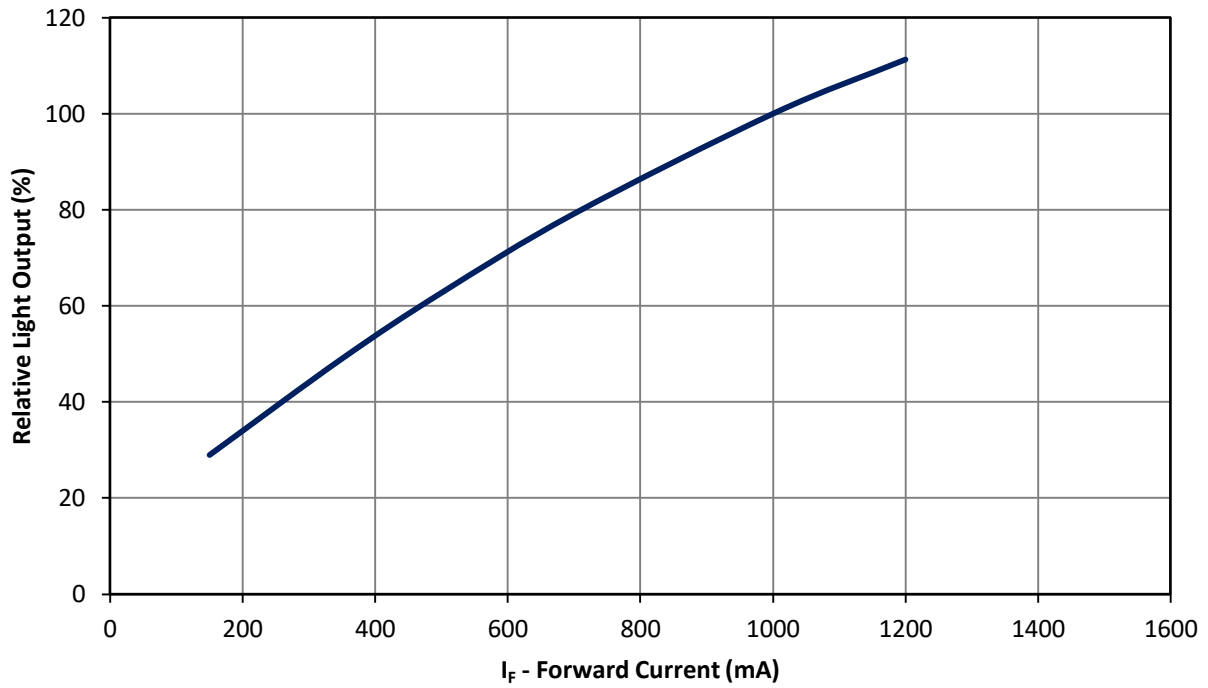

Figure 7: Typical relative light output vs. forward current @ $T_c = 25^\circ\text{C}$.

Typical Relative Light Output over Temperature

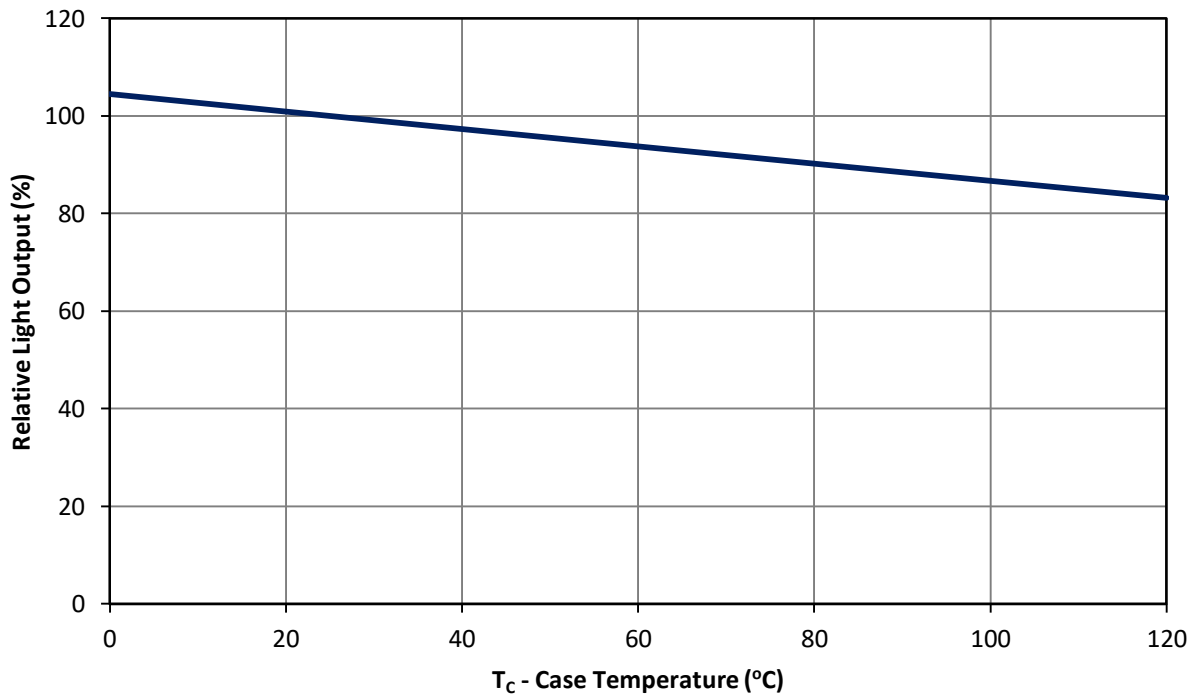

Figure 8: Typical relative light output vs. case temperature.

Typical Dominant Wavelength Shift over Current

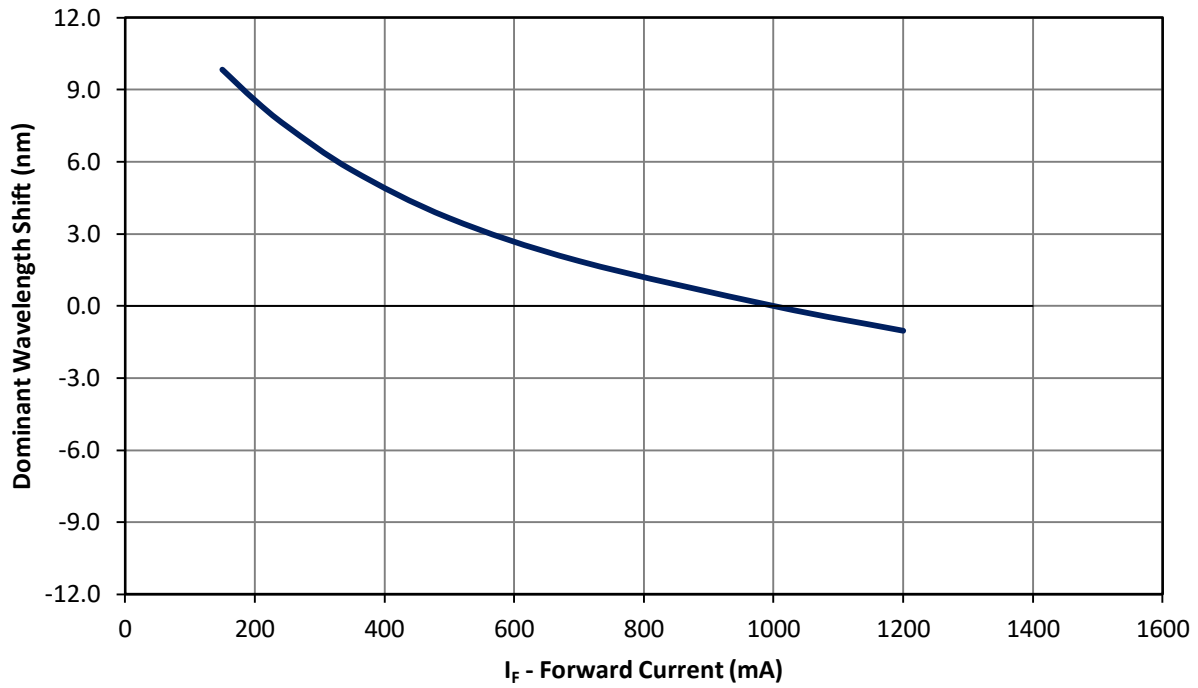

Figure 9: Typical dominant wavelength shift vs. forward current @ T_c = 25°C.

Typical Relative Dominant Wavelength Shift over Temperature

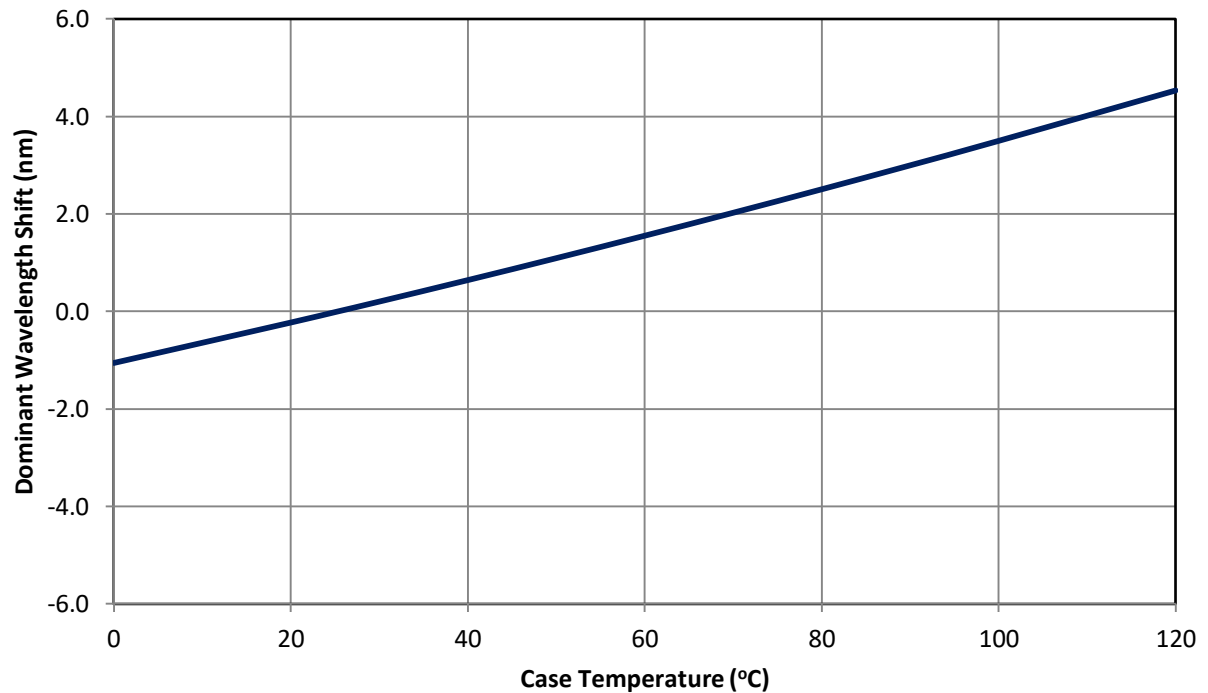

Figure 10: Typical dominant wavelength shift vs. case temperature.

Current Derating

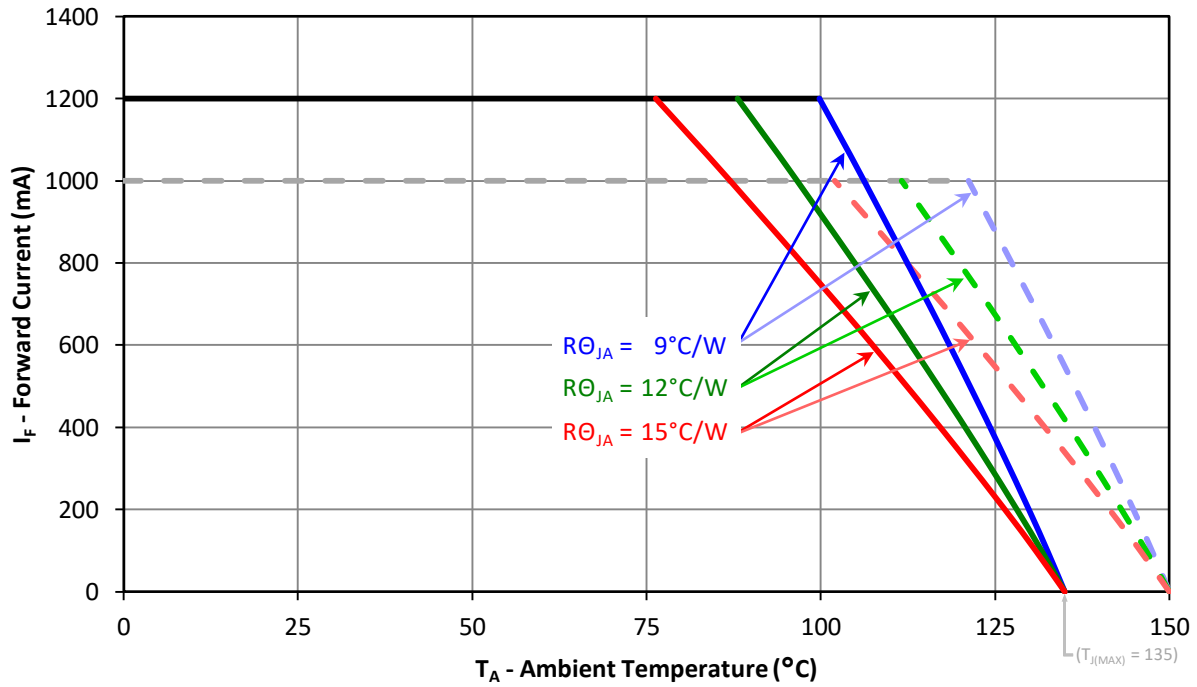

Figure 11: Maximum forward current vs. ambient temperature

Notes for Figure 11:

1. $R\theta_{j-c}$ [Junction to Case Thermal Resistance] for the LZ1-00G102 is typically 6°C/W .
2. $R\theta_{j-a}$ [Junction to Ambient Thermal Resistance] = $R\theta_{j-c}$ + $R\theta_{c-a}$ [Case to Ambient Thermal Resistance].

Emitter Tape and Reel Specifications (mm)

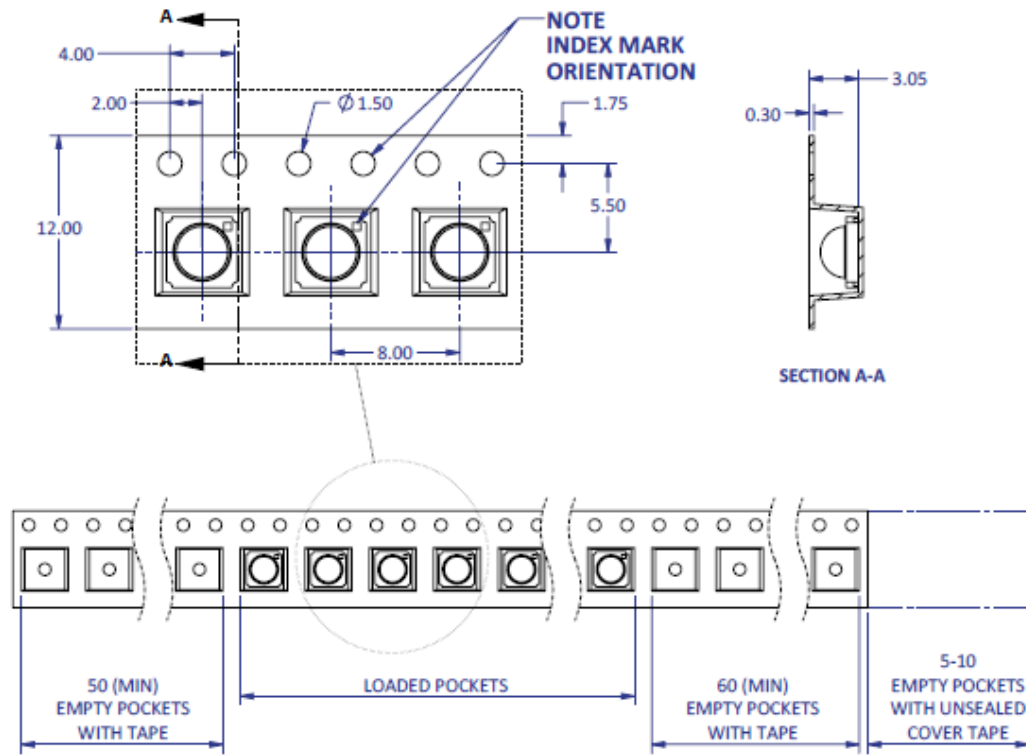

Figure 12: Emitter carrier tape specifications (mm).

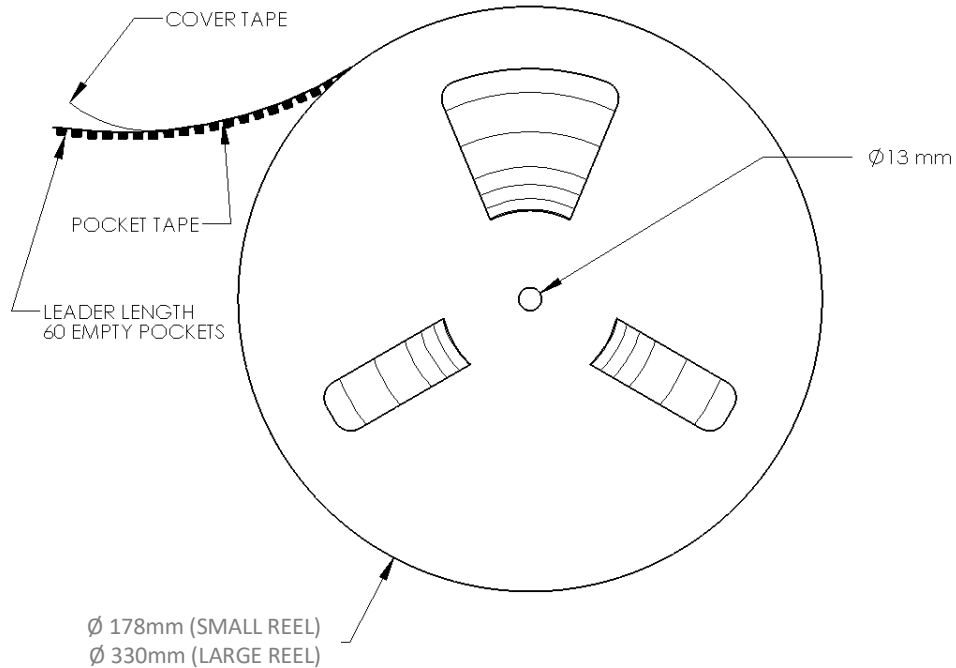

Figure 13: Emitter reel specifications (mm).

Notes:

1. Small reel quantity: up to 500 emitters
2. Large reel quantity: 501-2500 emitters.
3. Single flux bin and single wavelength bin per reel.

LZ1 MCPCB Family

Part number	Type of MCPCB	Diameter (mm)	Emitter + MCPCB Thermal Resistance (°C/W)	Typical V _F (V)	Typical I _F (mA)
LZ1-1xxxxx	1-channel Star	19.9	6.0 + 1.5 = 7.5	3.75	1000

Mechanical Mounting of MCPCB

- MCPCB bending should be avoided as it will cause mechanical stress on the emitter, which could lead to substrate cracking and subsequently LED dies cracking.
- To avoid MCPCB bending:
 - Special attention needs to be paid to the flatness of the heat sink surface and the torque on the screws.
 - Care must be taken when securing the board to the heat sink. This can be done by tightening three M3 screws (or #4-40) in steps and not all the way through at once. Using fewer than three screws will increase the likelihood of board bending.
 - It is recommended to always use plastics washers in combinations with the three screws.
 - If non-taped holes are used with self-tapping screws, it is advised to back out the screws slightly after tightening (with controlled torque) and then re-tighten the screws again.

Thermal interface material

- To properly transfer heat from LED emitter to heat sink, a thermally conductive material is required when mounting the MCPCB on to the heat sink.
- There are several varieties of such material: thermal paste, thermal pads, phase change materials and thermal epoxies. An example of such material is Electrolube EHTC.
- It is critical to verify the material's thermal resistance to be sufficient for the selected emitter and its operating conditions.
- It is recommended to verify thermal design by measuring case temperature (T_c) during design phase.

Wire soldering

- To ease soldering wire to MCPCB process, it is advised to preheat the MCPCB on a hot plate of 125-150°C. Subsequently, apply the solder and additional heat from the solder iron will initiate a good solder reflow. It is recommended to use a solder iron of more than 60W.
- It is advised to use lead-free, no-clean solder. For example: SN-96.5 AG-3.0 CU 0.5 #58/275 from Kester (pn: 24-7068-7601)

LZ1-1xxxxx

1 channel, Standard Star MCPCB (1x1) Dimensions (mm)

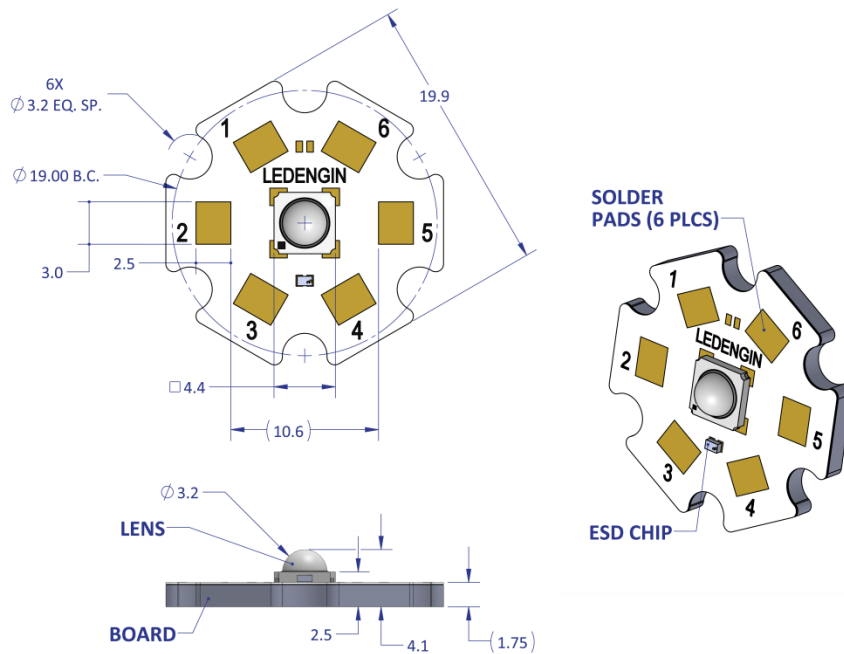

Notes:

- Unless otherwise noted, the tolerance = ± 0.2 mm.
- Slots in MCPCB are for M3 or #4-40 mounting screws.
- LED Engin recommends plastic washers to electrically insulate screws from solder pads and electrical traces.
- LED Engin recommends using thermal interface material when attaching the MCPCB to a heat sink.
- The thermal resistance of the MCPCB is: $RO_{C-B} 1.5^{\circ}\text{C/W}$

Components used

MCPCB: HT04503 (Bergquist)
 ESD/TVS diode: BZT52C5V1LP-7 (Diodes, Inc., for 1 LED die)
 VBUS05L1-DD1 (Vishay Semiconductors, for 1 LED die)

Pad layout			
Ch.	MCPCB Pad	String/die	Function
1	1,2,3	1/A	Cathode -
	4,5,6		Anode +

About LED Engin

LED Engin, an OSRAM business based in California's Silicon Valley, develops, manufactures, and sells advanced LED emitters, optics and light engines to create uncompromised lighting experiences for a wide range of entertainment, architectural, general lighting and specialty applications. LuxiGen™ multi-die emitter and secondary lens combinations reliably deliver industry-leading flux density, upwards of 5000 quality lumens to a target, in a wide spectrum of colors including whites, tunable whites, multi-color and UV LEDs in a unique patented compact ceramic package. Our LuxiTune™ series of tunable white lighting modules leverage our LuxiGen emitters and lenses to deliver quality, control, freedom and high density tunable white light solutions for a broad range of new recessed and downlighting applications. The small size, yet remarkably powerful beam output and superior in-source color mixing, allows for a previously unobtainable freedom of design wherever high-flux density, directional light is required. LED Engin is committed to providing products that conserve natural resources and reduce greenhouse emissions; and reserves the right to make changes to improve performance without notice.

For more information, please contact LEDE-Sales@osram.com or +1 408 922-7200.