



# Light is FLEXible

## Book of inspiration

Unique lighting design to create spectacular illumination

Light is **OSRAM**

**OSRAM**

# The new lightness of design

A basic need, an economic factor and a source of inspiration – light is all that. Used skillfully, lighting can bring buildings to life, highlight works of art and create a comfortable atmosphere. Light becomes an integral part of architecture, simulates daylight and fulfills many essential functions in our daily lives that go far beyond mere illumination.

The limits of what is technically feasible are pushed further and further. New ideas are born every day and rapid technical progress provides innovative solutions for creative light design. With solutions from OSRAM, you are best prepared to tap the full potential of light in all its facets. Let yourself be inspired by the amazing options provided by state-of-the-art light design.



---

# Handrails

01

Pathways of inspiration



---

# Cove lighting

02

Perfect interior design



---

# Luminous ceilings

03

Interior rooms that reach up to the sky



---

# Wall integration

04

Extraordinary highlights



---

# Facade design

05

Attracting attention from a distance



---

# Architectural lighting

06

Design elements that spark inspiration



---

# Products

07

Lighting technology at its best



HANDRAILS

BEHIND THE SCENES ▶

# 01 PATHWAYS OF INSPIRATION





## Elevating experience, spectacular sight

### “Cykelslangen”, Copenhagen

Client: Municipality of Copenhagen; Architect: DISSING+WEITLING architecture (DK); Engineer: Rambøll (DK); Contractor: MT Højgaard (DK); Landscape Architect: Marianne Levinsen Landskab (DK); Light Design: Lasse Marcussen, Lightconstructor (DK)  
Product: LINEARlight Flex® Uniformity

Opened in June 2014, the “Cykelslangen” (“Cycle Snake”) is the latest addition to one of the most bicycle-friendly city infrastructures in the world. The light for the elevated cycle path was required to follow the contours of the structure and be fully integrated along the line of movement. LINEARlight Flex® Uniformity LED modules from OSRAM were the best choice. Thanks to very short spacings between the individual LEDs, they form an unbroken line of light, providing aesthetic lighting that not only looks cool but also exceeds the requirements of the relevant traffic safety regulations. In addition to its practicality, “Cykelslangen” makes riding a bike more fun and also offers an extraordinary view from the harbor front below that is even more spectacular at night thanks to the LED lighting from OSRAM.

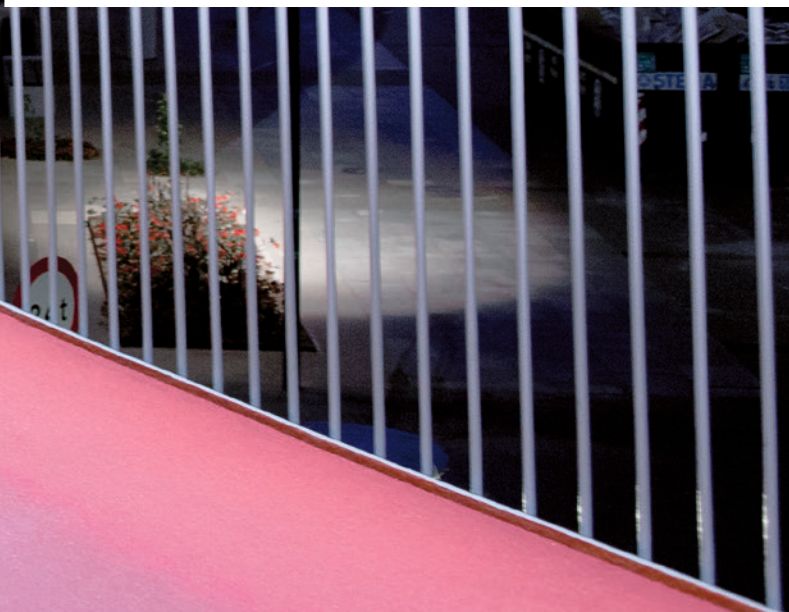

## FOR MORE INSPIRATION

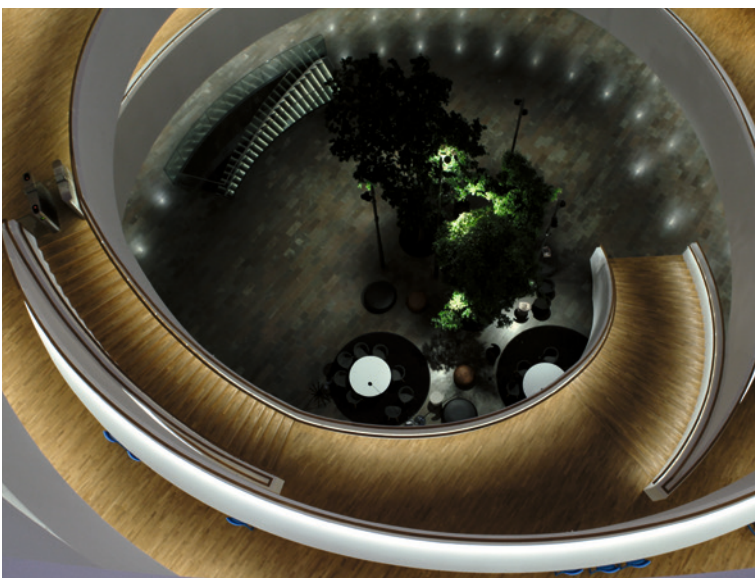
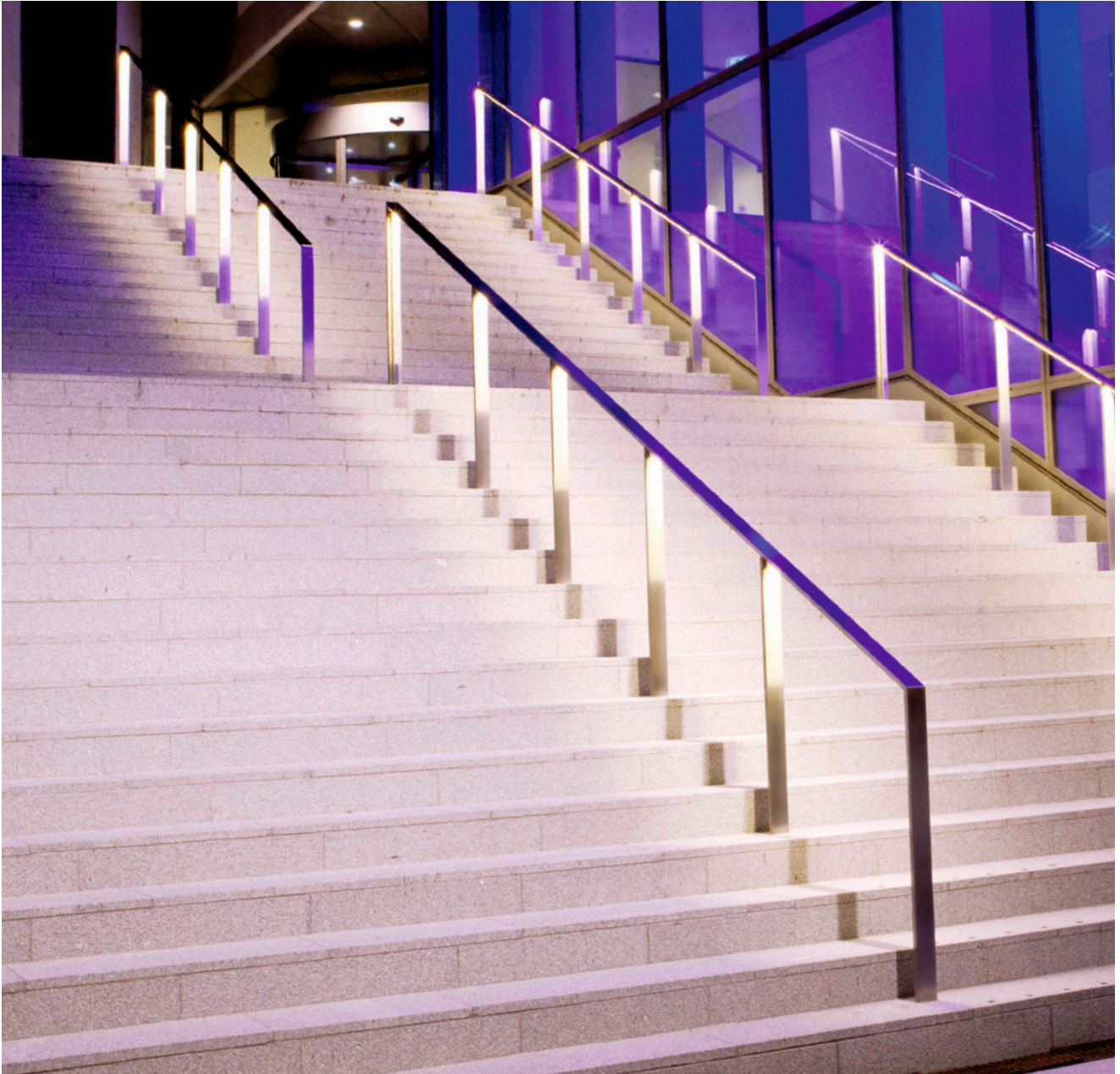

### **Setting the stage for cutting-edge lighting design**

They come in elegant curves, in straight and clear lines or with fantastic angles: Depending on their function and architectural style, steps and stairways can open up a multitude of possibilities for creative lighting designers. Homogeneous lines of light emphasize architectural structures and highlight a building's overall appearance. Apart from serving its primary task of safety, light is playing a more and more important role in designing brilliant architecture. Once integrated, LED modules smoothly follow the shape of a handrail, creating homogeneous bands of light that even vary their color to match the desired atmosphere.

# SOLUTION COMPETENCE IN DETAIL

## Slim lighting solutions

To create an elegant overall look, handrails often have very slim dimensions. For these applications, OSRAM offers extremely slim drivers and LED modules which ensure that homogeneous and shadow-free bands of light are created when integrated into the handrail – even in confined spaces.

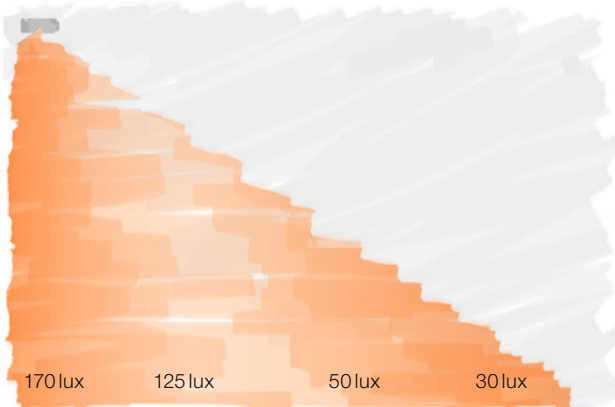
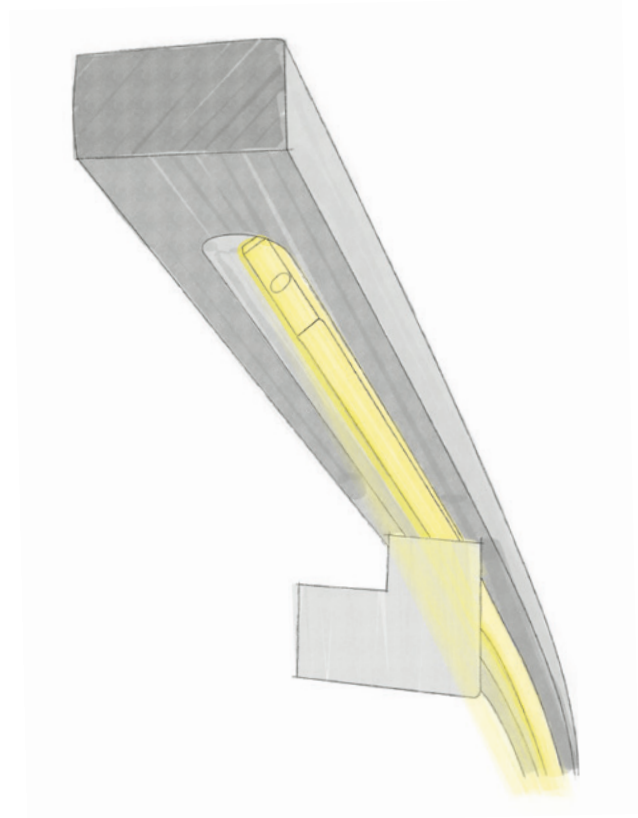

## Providing optimal illumination

When planning lighting solutions, the homogeneous illumination of defined areas using lighting systems integrated into handrails represents a special challenge. In addition to complying with statutory regulations, LED modules must be integrated in such a way that the illuminance required is available at every section of the rail without glare for passers-by. The selection of the right LED modules and also the angle at which these are built into the handrails is therefore of prime importance.

## Reliable in any kind of weather

For outdoor applications, the entire lighting system must be able to resist all weather conditions. To ensure this, OSRAM has LED modules with special coating and rugged LED drivers in its portfolio. These are designed to withstand temperature variations, wet conditions or dust. Shining examples are LED modules with high performance silicon potting and drivers that can be additionally enclosed in so-called outdoor tubes, as well as versions with integrated protection and potted cables.

## Innovative concepts beyond standard solutions

Today's lighting design is characterized by a broad range of application options enabled by modern light management. And the considerations of engineers and designers have long since gone beyond lighting concepts that "only" provide perfect illumination. OSRAM is therefore constantly developing innovative lighting solutions which, for example, also include the tracking of passers-by. Using motion detectors, the illuminance can be increased precisely when and if a person passes near a connected source of light. The system also enables sophisticated guidance options that even react to certain groups of people by displaying different light colors.

COVE LIGHTING

BEHIND THE SCENES ▶

# PERFECT INTERIOR DESIGN



## The art of restrained accentuation

Museum Himmlisches Theater, Stift Neuzelle

Light planning: Konzeptlicht, Berlin  
Photographer: Andreas Tauber  
Product: LINEARlight Power Flex® Protect

The Neuzelle passion narratives of the holy grave, unique in Europe, illustrate the biblical incidence of the suffering, dying and resurrection of Jesus Christ in 15 scenes and five stage settings. The modern lighting concept focuses on a discreet illumination, which meets the requirements of monument conversation and emphasizes the historic character of the rooms. Directly integrated into the column capitals, LED strips from OSRAM create the indirect general illumination for the side exhibition room. In the "adaption corridor", four lateral indirect light lines help the visitor to adapt to the relatively low illuminance of the main exhibition room. There as well, white and color-changing LED strips provide an impressive but restrained accentuation.



02

*Sein Grab  
wird herrlich sein*



# FOR MORE INSPIRATION



## Indirect light to create atmospheric lighting

Enabling the perfect symbiosis of pleasant ambience and systematic functionality, light coves provide a harmonious room atmosphere in a wide variety of applications. LED strips are concealed in recesses or behind ledges so that they cannot be seen from any point of view. In place of using visible luminaires, indirect lighting is an effective means for implementing a consistent room lighting concept. Light appears to emerge from the ceiling or walls to create a floating, unobtrusive and harmonious atmosphere. Freedom of design is virtually unlimited because indirect light provides valuable benefits for homogeneous basic lighting, accentuating architectural features, or as a decorative design element.



# SOLUTION COMPETENCE IN DETAIL

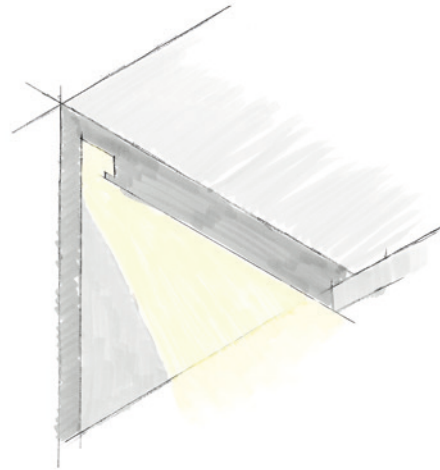
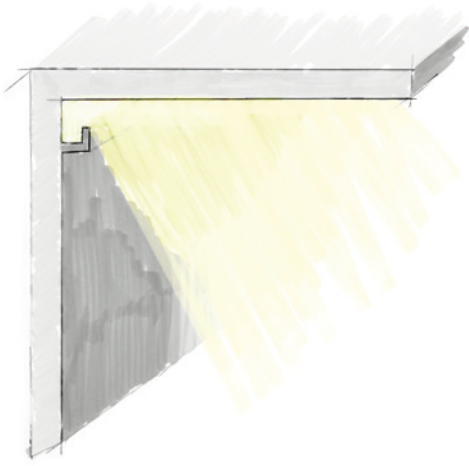

## Interior design with utmost flexibility

Light coves open up a multitude of options for creating a perfect atmosphere. Homogeneous lines of light delicately accentuate a room's geometry, decoratively highlight certain elements, or provide soft and uniform basic lighting. Flexible OSRAM LED modules are the perfect choice for designing the most effective solutions – including simple, exposed coves (see illustration above) and also ceiling-integrated elements (see illustration on the right). These provide the basis for attractive lighting to generate a sophisticated light setting in any room, for any application, and at any time of day.

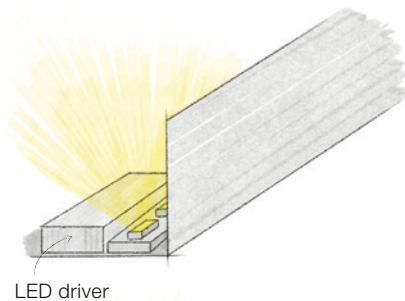
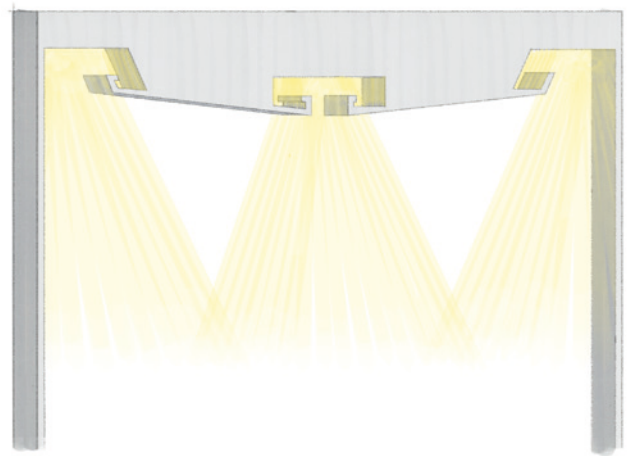

LED driver

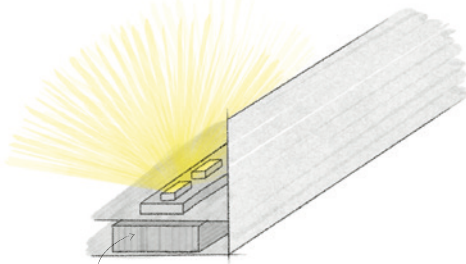

LED driver

## Effective thermal management

Since light coves usually consist of dry construction elements which cannot sufficiently distribute and dissipate heat, it is essential to install the LED modules in aluminum rails serving as stable carriers and providing for thermal management.

## Ever smaller, slimmer and more elegant

State-of-the-art room concepts require modern light coves with ever smaller dimensions to elegantly and discreetly blend into the overall design. Thanks to their outstanding features, the specially developed OSRAM ShortPitch modules easily fulfill this requirement. Shorter distances between the light points even enable absolutely homogeneous lines of light in installations close to a wall. There is also the option of using particularly slim and flat LED drivers that avoid shadowing effects when installed in the cove (see illustration on the left).

## Homogeneous extension of light lines

Absolutely even illumination is the key prerequisite for professional lighting concepts – and in this regard, the OSRAM SLIMCONNECT-system fulfills the highest expectations. Thanks to these practice-oriented accessories the modules can be easily connected to both the power supply and to each other without the need for tools, ensuring that the distance between the light points of adjoining modules always remains the same. Homogeneous lines of light can thus be extended in the twinkling of an eye.

LUMINOUS CEILINGS

BEHIND THE SCENES 

03

INTERIOR  
ROOMS THAT  
REACH UP  
TO THE SKY





# Brightly illuminated, open for success

## U-Center, Bucharest

Stretch ceiling: Barrisol, Kembs  
Planning and installation: Alibi Gloria, Brasov  
Product: BackLED Area Tunable White

Thanks to utmost lighting comfort, the U-Center office complex in Bucharest, Romania, greets its visitors with a lobby that provides a pleasant, open and welcoming atmosphere. Behind its vast stretch ceiling from French manufacturer Barrisol, the Romanian lighting specialist Alibi Gloria installed energy-efficient BackLED Area Tunable White LED panels from OSRAM. They illuminate the elegant room below in natural, vibrant colors that emphasize the high quality of the materials used for interior design. With a uniformly backlit area of 210 m<sup>2</sup>, OSRAM helped the operators create an artificial sky that says: We're open for business and ready for success.



# FOR MORE INSPIRATION

## Reaching up to the sky

Luminous ceilings and walls seamlessly combine an attractive appearance with practical functionality. They open a room toward the sky to make it appear higher, lighter and clearer. Light becomes an effective means of accentuating architectural structures – and thus creates a magic of its own. Shadow-free illuminated elements appear to float through space, giving hotels, museums or sales rooms their special appeal. The mood of the lighting can be variably adapted to a room's special architecture and purpose, creating powerful and colorful light accents, brightly illuminating certain areas, or generating a warm atmosphere with more subdued light colors.



Kempinski Hotel Corvinus Budapest / MKO Design Ltd., UK



# SOLUTION COMPETENCE IN DETAIL

## Large-area luminous ceilings for an excellent ambience

The quality of light plays a major role in the planning of luminous ceilings. To achieve homogeneous lighting, the light color and luminance must be adjusted with high precision. The minimum illumination to be achieved in an area must be determined first. For this calculation, the lighting situation is simulated and the required brightness is determined. OSRAM uses customized programs which optimally support the planning processes.

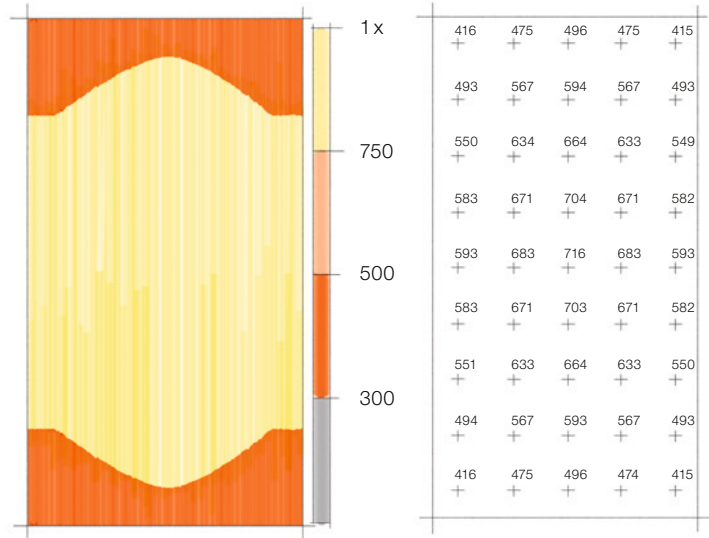

Afterwards, a plan specifying the exact number and arrangement of the LED modules required is presented to the customer. The modules are installed on mounting rails attached to the ceiling. Thanks to the defined distance between the light points and the seamless matching of all components, the desired lighting effect can be easily achieved.

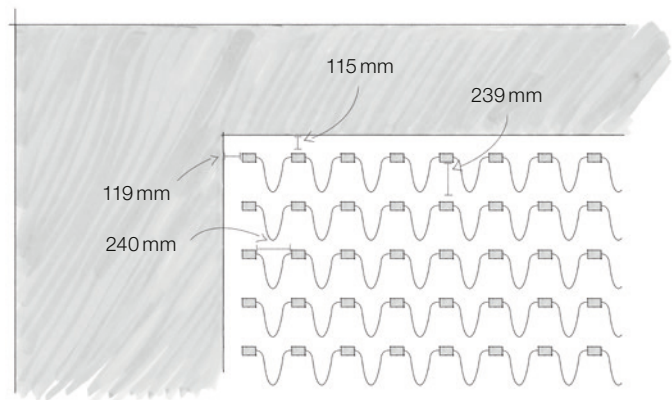

To optimize the lighting, it is advisable to provide a transparent extra layer between the LED modules and the diffuser. This prevents dust or dead insects from collecting on the diffuser and creating unpleasant shadows on the luminous ceiling. In many cases, this option is simpler and more cost-efficient than sealing the entire application against dust.

# 04 EXTRAORDINARY HIGHLIGHTS

„Franz Beckenbauer verfügte über das göttliche Geschenk eines Talentes, das nach jahrelanger gewissenhafter und unermüdlicher Entwicklung vorbildlich für die Fußballjugend in aller Welt war.“  
Detmar Cramer

„Franz Beckenbauer possessed an extraordinary talent and relentless development all over the world.“  
Detmar Cramer

1945 1950 1960



**MEINE WELTKARREERE  
WELKE ABGANGSSTADT**

„Ich bin der aller...“







## Turning successes into emotional highlights

### FC Bayern "Erlebniswelt", Munich

Exhibition design: Ranger Design, Stuttgart  
Light planning: Ulrike Brandt Licht, Munich  
Product: LINEARlight FLEX® Protect

Fan culture at its best – this is what the "Hall of Fame" of the FC Bayern München soccer club is all about. A spectacular presentation immortalizes 16 life-sized players on large round displays. Soccer legends such as Franz Beckenbauer, Gerd Müller and Sepp Maier are surrounded by "golden" lines of light running along the top and the bottom of the display. The light strips in this "Hall of Fame" illustrate the various stages in the players' lives and shine in brilliant colors to commemorate the greatest FC Bayern stars of different eras.

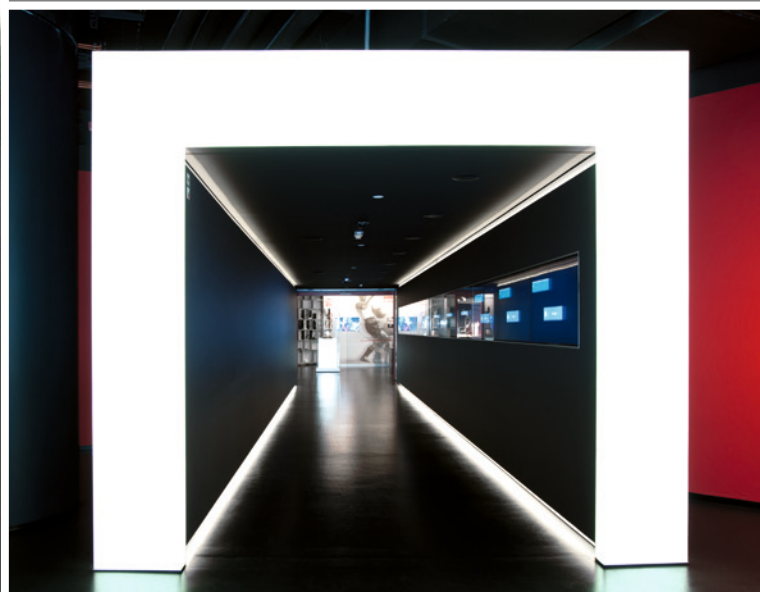

## FOR MORE INSPIRATION



Photo: müllerundröhrig GmbH



### **Bringing walls, ceilings and floors to life**

Accentuating architectural structures through lines of light provides great freedom of design. This is the perfect stylistic means to highlight straight lines, curved contours and organic shapes. To emphasize a room's special geometric characteristics, flexible bands of light are integrated into ceilings, walls or even into the floor. Seamless and shadow-free light guidance enables the most various lighting scenarios, with indirect light brilliantly highlighting all the different materials and surface structures.

# SOLUTION COMPETENCE IN DETAIL

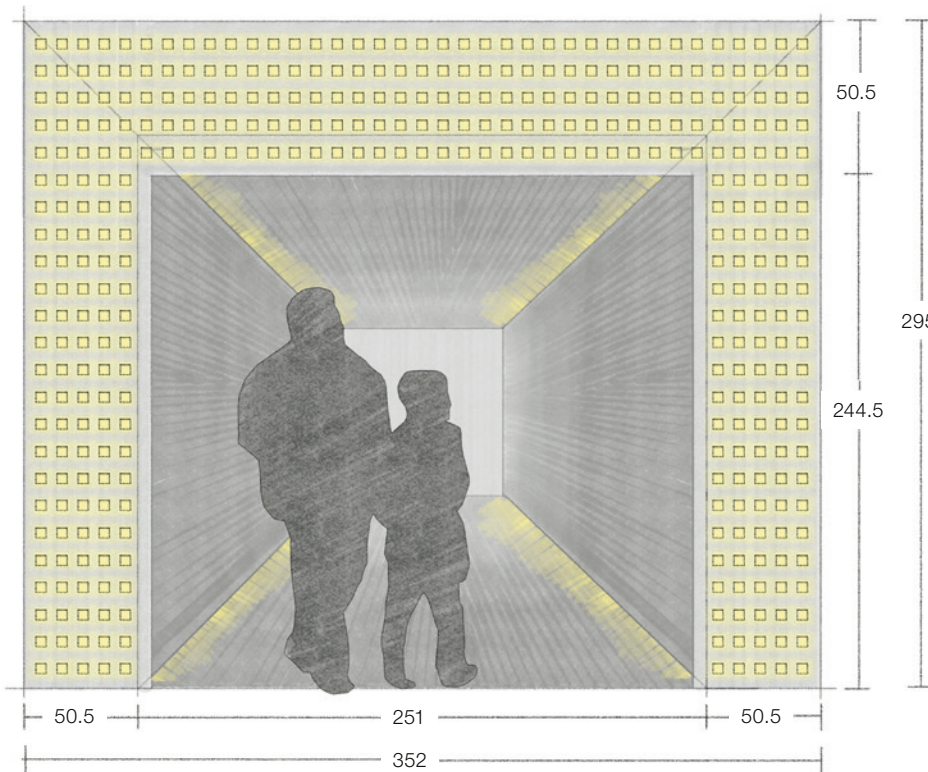

## Homogeneous arc of light

The special challenge of planning an arc of light is the homogeneous and shadow-free illumination of an entire area. The optimal distance between the modules, the correct beam angle of the LEDs and their distance to the diffuser area are of prime importance in this regard.

## Floor lighting to create visual effects

When integrating lighting technology into the floor, the light channel has to fulfill special requirements. To present objects in the perfect light, the luminance level must be defined first. The aluminum profiles must be installed in either a straight line or at the correct angle to achieve suitable values. The profiles carrying the LED modules also provide for thermal management. Suitable diffuser covers ensure that it is possible to walk over the light channels without glare for passers-by.

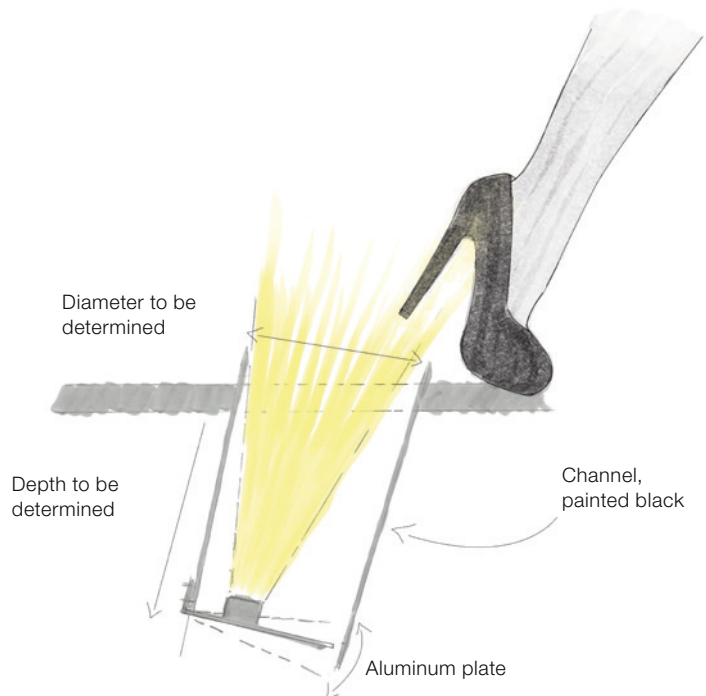

## Intelligent guidance systems

Modern light management also reveals new opportunities with orientation lighting. People can be identified by intelligent tracking systems and guided individually by light strips. The light strip intended for the desired travel path is activated automatically. Using Tunable White or RGB colors, this innovative guidance technology enables the assignment of light colors for specific purposes. The light strips do not have to be continuous; isolated applications are also possible.



# ATTRACTING ATTENTION FROM A DISTANCE



## Eye-catching interplay of architecture and light

### Freiheitshalle, Hof

Architecture: Seemüller GmbH, Bamberg

Lighting solution: nmd – Licht am Bau GmbH, Dresden

Product: BackLED M

The “Freiheitshalle” in the Bavarian city of Hof literally stands out thanks to its futuristic roof design catching attention from a distance. When the glass roof of this multi-function venue is illuminated in brilliant blue in the evening hours, it looks like a gigantic UFO hovering in the air. Powerful lines of light attractively accentuating the crystalline roof structure create this building’s distinctive appearance.



## FOR MORE INSPIRATION



### **Attracting customers from a distance**

More and more shopping malls, museums and public buildings are benefiting from state-of-the-art lighting design to ensure that their facades catch attention from a distance. A facade that makes a great first impression draws customers into the building. In fact, sophisticated facade design can provide a building with a unique and outstanding character, making it a city landmark. The clever use of light has become a major instrument for intelligent city planning. Architectural structures are spectacularly emphasized to ensure that a building stands out from a distance.



Photos: müllerundröhrig GmbH

# SOLUTION COMPETENCE IN DETAIL

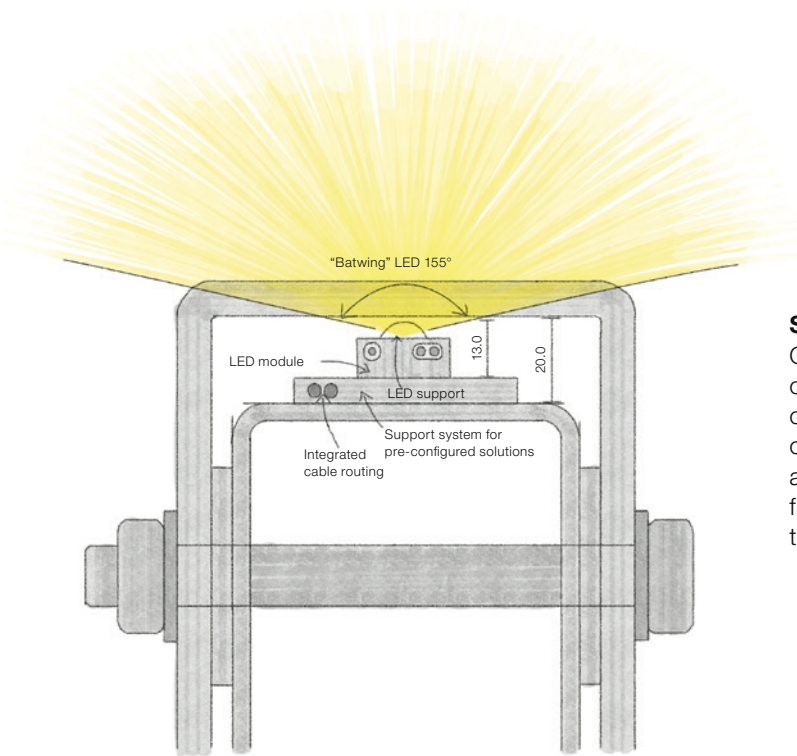

## Special concepts for special buildings

OSRAM lighting systems are the perfect choice for specifically adapting individual components to the installation site. By precisely adjusting components to special architectural characteristics, even complex facades with asymmetrical or winding structures can be bathed in brilliant light.

## Light source and diffuser perfectly matched to each other

The seamless interaction of the light source and the diffuser is a key prerequisite for achieving an impressive lighting effect. High-quality components enable the precise and homogeneous adjustment of the desired color shades. Here, the optical effect of the diffuser while the illumination is switched off must also be considered.

## High-quality accessories to save costs

OSRAM components are perfectly matched to each other. Entire assemblies can be pre-configured to facilitate assembly and installation on site. Thanks to extended maintenance intervals and easy handling, high-quality accessories also prove their worth in the fields of maintenance and replacement.

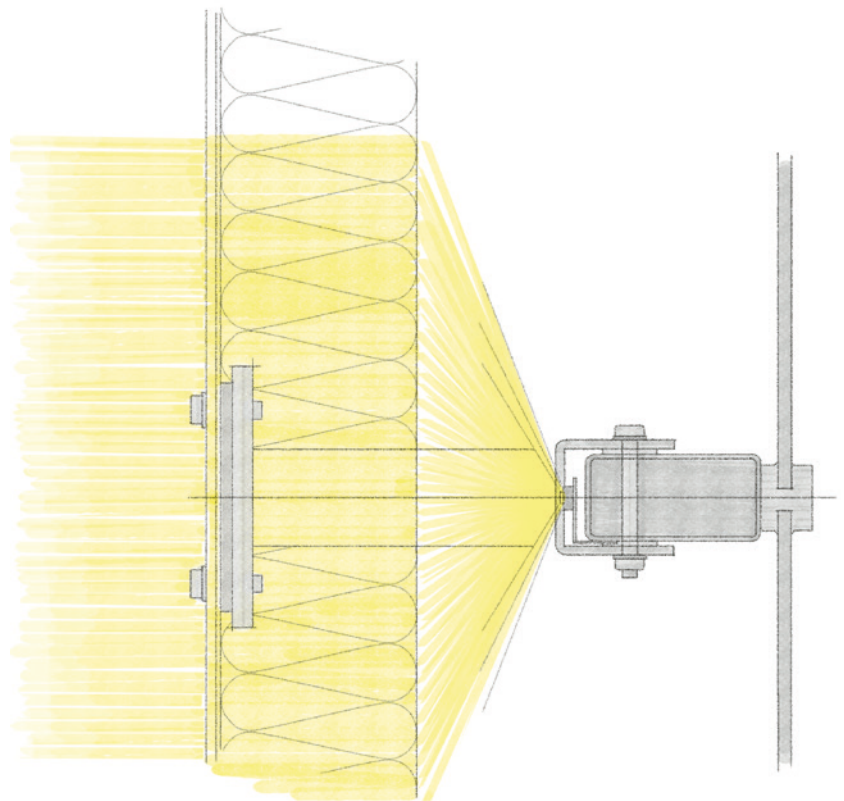

## High performance in any kind of weather

Components are exposed to strong winds and challenging weather conditions. This also applies to LED components which are expected to resist UV radiation, rain, cold, heat and dust over many years. OSRAM high-quality lighting systems provide full performance over many years.

ARCHITECTURAL  
LIGHTING

BEHIND THE SCENES 

DESIGN ELEMENTS THAT  
SPARK INSPIRATION







## Smooth design structures to create a new feeling of lightness

### Warsaw School of Economics (SGH)

Responsible for the project: Makro-Budomat Development Sp. z o.o.  
Product: LINEARlight FLEX RGBW

At first glance, the gigantic pyramidal glass roof stretching over the main hall of the Warsaw School of Economics, also referred to as the “parachute hall”, might appear rather compact and heavy. However, the innovative light concept lends this massive building an unprecedented appearance of lightness. All 224 windows of the “parachute” in the atrium can be illuminated individually, creating a fascinating lighting effect altogether. Every window can be dynamically controlled in order to achieve awe-inspiring light scenarios of filigree beauty on the roof.



# FOR MORE INSPIRATION

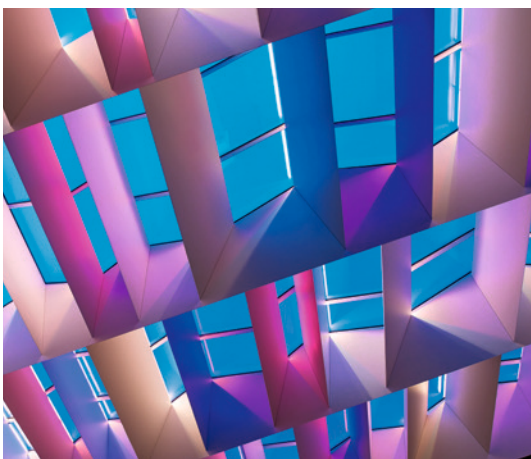

Design by Astrid Krøgh ([www.astridkrogh.com](http://www.astridkrogh.com))

## The fourth dimension of architecture

Light is the lifeblood of any architecture: it softens hard contours, accentuates geometrical structures and can be tailored to meet specific user requirements. This is how it brings an entire building to life. Light communicates emotions and creates a pleasant atmosphere – and achieving the right balance between daylight and artificial light is a major factor here. The perfect illumination of the building's structures is therefore an essential architectural design element.

# SOLUTION COMPETENCE IN DETAIL

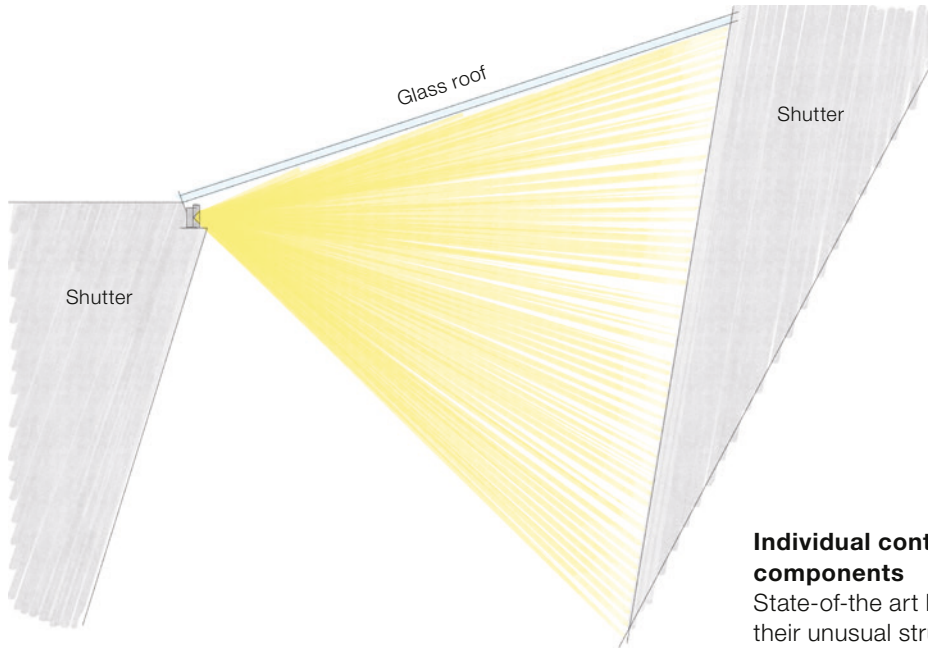

## Individual control of the most varied components

State-of-the-art buildings stand out thanks to their unusual structures and shapes. However, glass roofs consisting of various asymmetrical elements present special challenges for the development of customized lighting systems. To allow as much daylight as possible to enter the building, special shutters are used. Thanks to smart light guidance, warm, glare-free light shines through the roof into the building. In addition, shutters can avoid any disturbing reflection caused by LED lighting, ensuring the smooth and homogeneous distribution of light in the entire building. To achieve this, flexible OSRAM LED modules enable high precision adjustment and perfect alignment to the shutter.

## Programming sophisticated light scenarios

Every light source can be precisely controlled via centralized control systems. The OSRAM light management system transmits the signal to DALI in order to provide dynamic color changes and particularly slow sequences. Complex light systems are controlled via an ECU server, which is usually designed and programmed to suit the specific requirements of the individual project.

**Please note:** Components used in glass roofs must comply with particularly strict quality standards. This applies to LED modules, drivers and also to the carrier plates and covers of luminaires. Since the components are exposed to intensive solar radiation, UV and temperature resistance as well as thermal management are of prime importance.

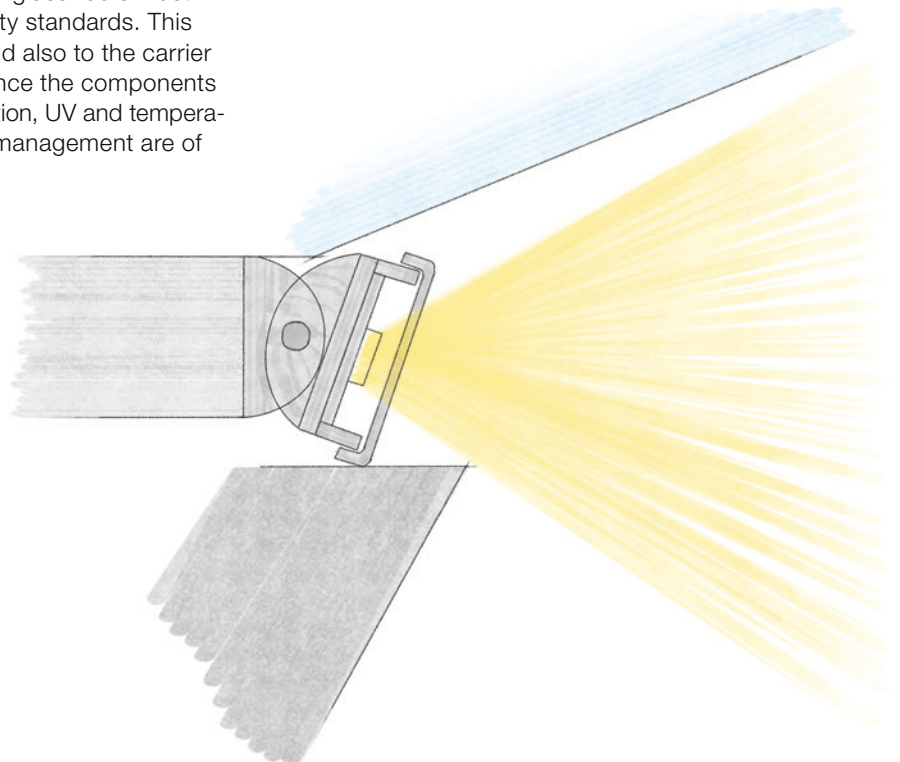

# Products recommended for the implementation of application examples

The following lists of items are provided as examples. They refer to the reference projects presented in this brochure.



## Products for handrail lighting

Product name	Function	EAN
LFP800S-G5-940-10	FLEX LED module	4062172170772
CONN-FLEX-IP67-2P	Feeder for module	4062172176590
OT FIT 80/220-240/24 P	IP-safe LED driver	4062172085465
LTS-SLIMTRACK-2000	Rail system	4062172207300



## Products for cove lighting

Product name	Function	EAN
LF800S-G5-930R-10	FLEX LED module	4062172170192
LFP800S-G5-830-10	FLEX LED module	4062172170536
LF1300RGBW-G1-830-04	FLEX LED module	4062172166195
OTi DALI 80/220-240/24 4CH DT6/8	4-channel DALI LED driver	4062172177924
OT FIT 75/220-240/24 PC	Phase-cut LED driver	4062172237413



## Products for luminous ceilings

Product name	Function	EAN
BA-AR-G1 900 540x270 TW	Tunable White backlighting module	4062172141642
BA-BAR	Holding bar	4062172197168
OTi DALI 160/220-240/24 2CH DT6/8	2-channel DALI LED driver	4062172177948
DALI MCU TW G2	DALI light management system	4062172224673



## Products for wall integration

Product name	Function	EAN
LFP500-G1-940-10	FLEX LED module	4052899575547
OTi DALI 210/220-240/24 1-4CH P	IP-safe 4-channel DALI LED driver	4062172032087
LTS-SLIMTRACK-2000	Rail system	4062172207300
CONN-FLEX-IP67-2P	Feeder for module	4062172176590
LTS-COVER-OPAL-S-2000	Rail system cover	4062172207324
BA-S-CP-865-24-G5	LED module for backlighting	4052899627970
OTi DALI 100/220-240/24 1-4CH P	IP-safe 4-channel DALI LED driver	4062172119191
BA-MP-SM-G5-2M	Mounting system	4052899629196
LTS-MOUNTINGBRACKET	Mounting bracket for rail system	4062172212090



## Products for facade design

Product name	Function	EAN
BA-M-CP-BLUE G4	LED module for backlighting	4062172183437
OT FIT 300/220-240/12 P	12V IP-safe LED driver	4062172133548
BA-MP-M-CP	Mounting system	4062172168410



## Products for architectural lighting

Product name	Function	EAN
LF1300RGBW-G1-840-04	FLEX LED module	4062172166218
CONN-FLEX-4P-200	Feeder for module	4062172179768
LTS-SLIMTRACK-2000	Rail system	4062172207300
LTS-MOUNTINGBRACKET	Mounting bracket for rail system	4062172212090
OT SLIM 250/220-240/24	24V Slim LED driver	4062172135917
OT DMX RGBW DIM	4-channel DMX LED dimmer	4052899557949
LTS-COVER-CLEAR-2000	Rail system cover	4062172207348



For more products from our portfolio – Flex and signage, accessories and light management systems– click here: [www.osram.com/flex](http://www.osram.com/flex)

# Do you need professional support?

Our experienced lighting professionals are at your service to consult you in the planning and successful implementation of your projects.

For technical questions, please do not hesitate to send an e-mail to one of the following addresses:

For FLEX, write to:  
[flex-support@osram.com](mailto:flex-support@osram.com)

For Signage, write to:  
[signage-support@osram.com](mailto:signage-support@osram.com)

[www.osram.com/backlighting](http://www.osram.com/backlighting)

[www.osram.com/led-designer](http://www.osram.com/led-designer)  
[signage-support@osram.com](mailto:signage-support@osram.com)

Your support for ...

- Backlighting
- Side lighting
- Light ceilings

**OSRAM**

[www.osram.com/flex](http://www.osram.com/flex)

[flex-support@osram.com](mailto:flex-support@osram.com)

Your support for ...

- Project planning
- Implementation
- Accessories

**OSRAM**

You want to contact us?  
Here you can find our worldwide sales contacts

[https://www.osram.com/ds/contact\\_2.jsp](https://www.osram.com/ds/contact_2.jsp)

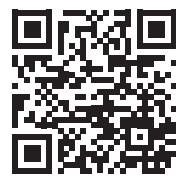

Need more support? As a registered customer,  
you can contact our experts by e-mail

[support-ds@osram.com](mailto:support-ds@osram.com)



Not a registered customer?  
Please use our contact form

<https://www.osram.com/apps/cbcontact/contacts/add>

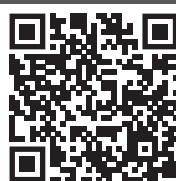

**OSRAM GmbH**

Headquarters Germany:

Marcel-Breuer-Strasse 6  
80807 Munich, Germany  
Phone +49 89 6213-0  
Fax +49 89 6213-2020  
[www.osram.com](http://www.osram.com)

**OSRAM**