

04/2023

Technical application guide  
LINEARlight FLEX Protect  
White and Tunable White  
products

**OSRAM**

---

**Contents**

<b>1 Product overview</b>	<b>03</b>	<b>3 System connection</b>	<b>17</b>
1.1 General features	03	3.1 Basic steps of system planning	17
1.2 Application areas	03	3.2 Standard connection	17
1.3 LINEARlight FLEX Protect LOW POWER	03	3.3 Parallel and series connection	17
1.4 LINEARlight FLEX Protect UNIFORMITY	03	3.4 Temperature	18
1.5 LINEARlight FLEX Protect POWER	04	3.5 Compatibility with LED drivers	18
1.6 LINEARlight FLEX Protect Tunable White	04		
1.7 Nomenclature	05		
1.8 Accessories	05		
<b>2 Installation</b>	<b>06</b>		
2.1 Precautionary measures	06		
2.2 Connection	07		
2.2.1 Basics	07		
2.2.2 Mechanical dimensions	08		
2.3 Assembly	09		
2.3.1 Assembly with CONN-FLEX-IP67-2P	09		
2.3.2 Assembly with JUMPER-FLEX-IP67-2P	10		
2.4 Profile system	11		
2.4.1 System overview	11		
2.4.2 LF-LTS-MB (mounting bracket)	16		
2.4.3 FX-QMS/QMW-B/S (mounting bracket and springs)	16		

# 1 Product overview

## 1.1 General features

- 24V LED strips, FLEXible and cuttable, (cut length is product-dependent) with superior optically graded silicone encapsulation
- Available **White** variants: 500lm/m, 800lm/m, 1200lm/m, 2000lm/m, 3000lm/m
- Available **Tunable White** (TW) variants: 1100lm/m, 3400lm/m
- CRI (R<sub>a</sub>): 95+, 90+ and 80+
- Up to 60,000h L90/B10 with SDT, tested acc. to IEC 62717 on real LED strips
- Stable luminous flux over length: Active constant-current regulators (ICs), PWM-safe
- Embedded automatic quick protection against accidental miswiring up to 25 V
- Fully PWM dimmable from zero up to 2.5kHz, audible noise free, suitable for quiet places
- Excellent ESD protection of up to 8 kV in air or 4 kV in contact (acc. to IEC 61547)
- IP67 with connector, IP66 with premounted feeders
- Salt-mist atmosphere resistant (acc. to IEC 60068-2-52, highest severity)
- UV radiation resistant (acc. to ISO 4892-2)
- Mixed flowing gas corrosion resistant (IEC 60068-2-60)
- Designed, engineered, manufactured and tested in Italy (ISO 9001, ISO 17025, ACCREDIA, VDE)
- Safe Dimming Technology (SDT) inside
- Easy installation
  - Connector or premounted feeder for easy connection
  - Adhesive tape for easy mounting
  - Connectors and aluminum profile system available
- Scalable system
  - LED module can be cut to required length
  - 24 V system with matching OPTOTRONIC LED driver and light management system

## 1.2 Application areas

LINEARlight FLEX Protect LED modules are suitable for the following outdoor applications:

- Façade accent lighting
- Ceiling integration
- Wall integration
- Cove lighting
- Path lighting
- Industrial equipment lighting

## 1.3 LINEARlight FLEX Protect LOW POWER

- Light output: up to 520lm/m
- Luminous efficacy: up to 133lm/W
- LEDs/m: 70
- Available colors: from 2700K to 8000K
- Available CRI: 80+/90+



LINEARlight FLEX Protect LOW POWER (LFP500-G1)

## 1.4 LINEARlight FLEX Protect UNIFORMITY

- Light output: from 800lm/m up to 2000lm/m
- Luminous efficacy: up to 135lm/W
- LEDs/m: 140
- Available colors: from 2500K up to 8000K
- Available CRI: 80+/90+/95+



LINEARlight FLEX Protect POWER UNIFORMITY (LFPxxxxS-G5)

### 1.5 LINEARlight FLEX Protect POWER

- Light output: from 800 lm/m up to 3000 lm/m
- Luminous efficacy: up to 135 lm/W
- LEDs/m: 70
- Available colors: from 2400 K up to 6000 K
- Available CRI: 80+/90+



LINEARlight FLEX Protect POWER (LFPxx00-G3)

### 1.6 LINEARlight FLEX Protect Tunable White

- Light output: 1100 lm/m and 3400 lm/m
- Luminous efficacy: up to 117 m/W
- LEDs/m: 186
- Available colors: 2500 K - 4000 K and 2700 K - 5700 K
- Available CRI: 80+/90+



LINEARlight FLEX Protect POWER Tunable White (LFPxx00TW - G5)

### 1.7 Nomenclature

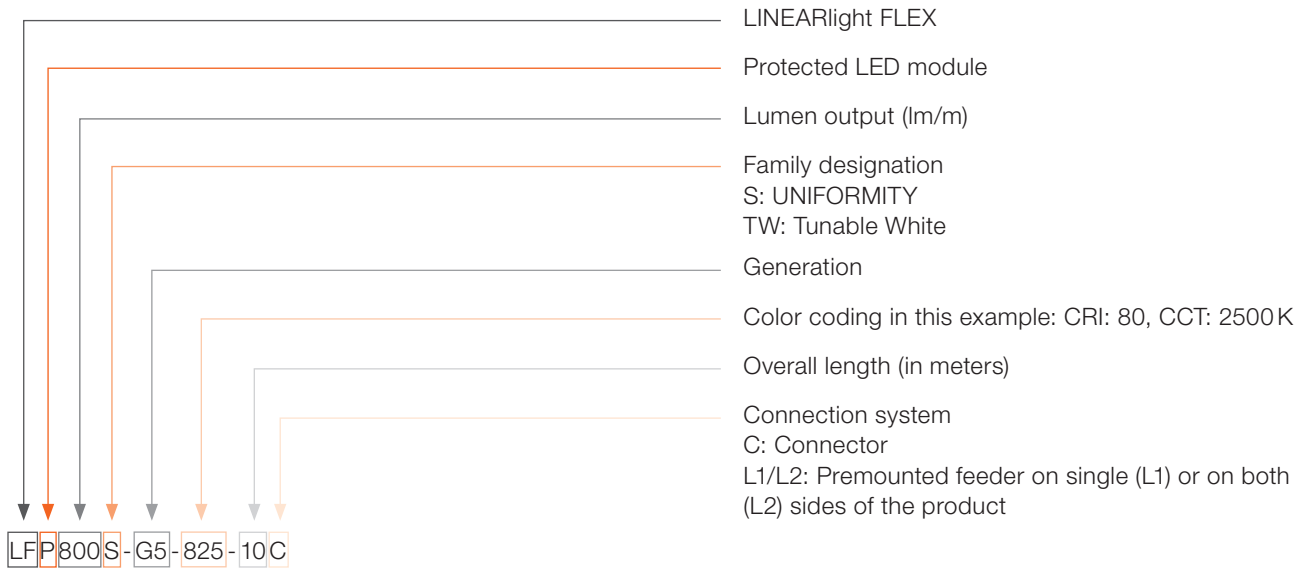

### 1.8 Accessories



CONNECTsystem IP67 LP

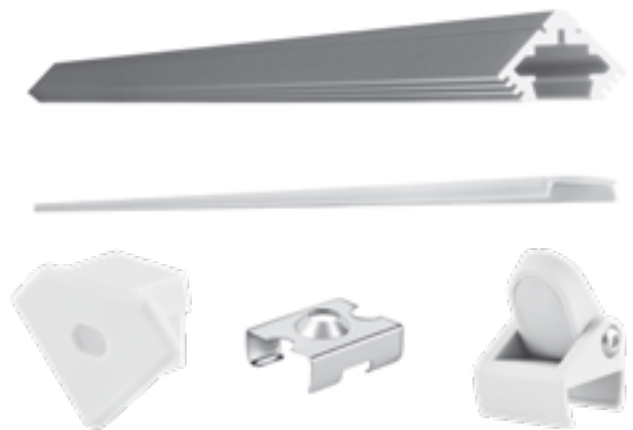

Flexessories:



OPTOTRONIC LED drivers and dimmers

# 2 Installation

## 2.1 Precautionary measures

Before the installation of LINEARlight FLEX Protect White and Tunable White LED modules, attention should always be paid to the following important issues.

### ESD

Be aware that the products can be damaged by electrostatic discharge (ESD). Earthing is a very effective measure to avoid damaging effects due to electrostatic discharge. Therefore, use a personal earthing system (ESD field kit) during mounting to prevent the build-up of static charge.



### Cleaning

Depending on the surface, use a multi-purpose cleaner, such as isopropyl alcohol, to provide a clean and dry mounting surface, which is free of oils, silicone coatings and dirt particles.

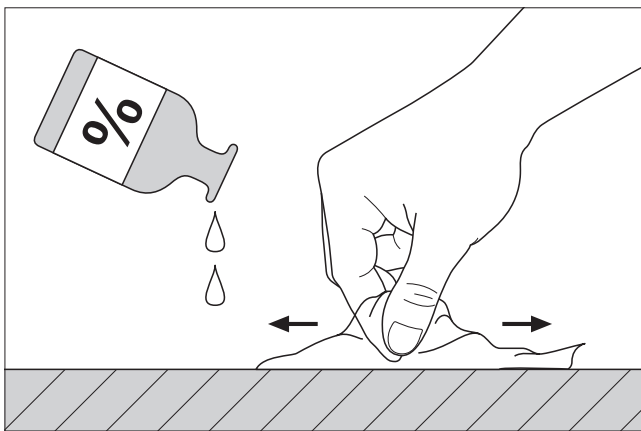

### Mechanical forces

Avoid mechanical forces on the connector (feeder) and the LEDs. A strain relief is recommended. In addition, mechanical stress must not be applied to the module itself (e.g. no twisting or bending in excess of the allowed radius as shown in the next images from 1 to 5).

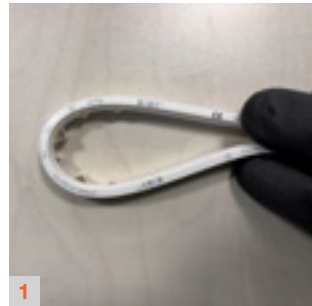

### IP rating

The IP rating specifies the degree of protection against the intrusion of solid objects (including body parts such as hands and fingers), dust and water in electrical enclosures. While the first digit of the IP rating indicates the protection against foreign bodies, the second digit indicates the protection against water. For more details on IP rating, please refer to "Technical application guide – IP codes in accordance with IEC 60529 and external environment impacts" available at: [www.inventronics-light.com](http://www.inventronics-light.com)

The following IP ratings apply to LINEARlight FLEX Protect White and Tunable White LED modules:

#### IP66:

- [6] Full protection against contact and penetration of dust
- [6] Protection against ingress of water in case of powerful water jets

#### IP67:

- [6] Full protection against contact and penetration of dust
- [7] Protection against ingress of water in case of temporary flooding



### Cutting

Ensure that the modules are cut properly at an angle of 90° before attaching the connector!

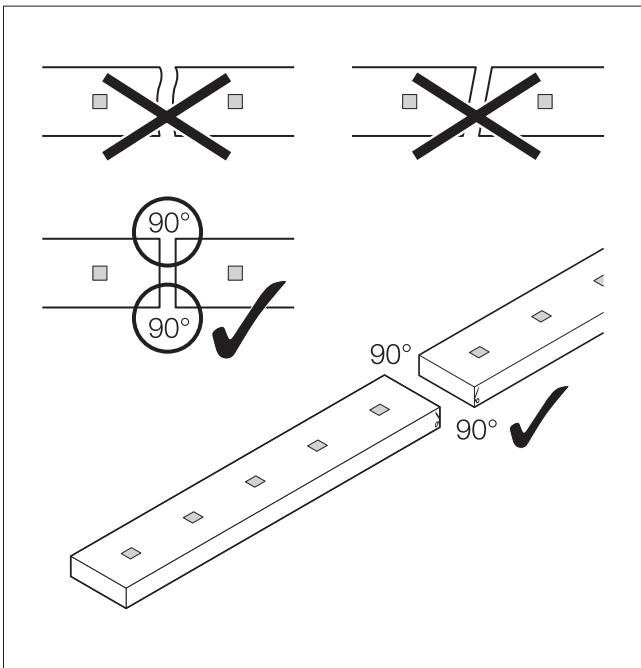

The end of each LINEARlight FLEX Protect LED strip (excluding the LFP1100TW version) consists of a section of about 4 to 5 cm of only silicone material. During the installation, this section can be cut without losing the IP rating of the LED module (for example, it is not necessary to install an end cap).



The right point where this cutting can be done is indicated by the symbol "End" marked on the side of each LFP product.



### 2.2 Connection

#### 2.2.1 Basics

LINEARlight FLEX Protect LED modules (White version) are compatible with the connectors available in the CONNECTsystem. There are two components that can be used:

- CONN-FLEX-IP67-2P: Connector used to light up one LED module
- JUMPER-FLEX-IP67-2P: Jumper used to connect two parts of the same type of LED module

Depending on which component is used in the application, the modules have to be cut at the appropriate mark.

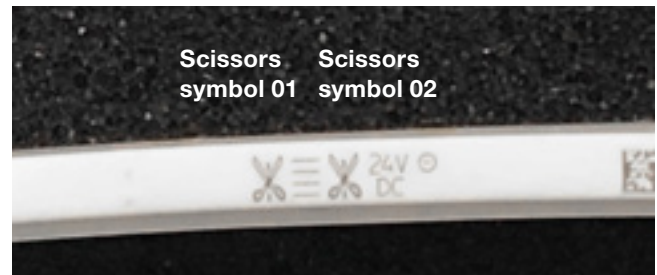

Cut at scissors symbol 01 to use:

- CONN-FLEX-IP67-2P
- Right head of JUMPER-FLEX-IP67-2P



Cut at scissors symbol 02 to use:

- Left head of JUMPER-FLEX-IP67-2P



LINEARlight Tunable White products are already wired and they are not compatible with the connectors available in the CONNECTsystem.

In particular, LFP1100TW versions have both sides available with premounted wires. In this case, once the LED module is cut, the customer can obtain two smaller lengths already available with wires.



LFP3400TW versions are shorter than LFP1100TW and for this reason, they have just one side already available with premounted wires.



### 2.2.2 Mechanical dimensions

To have a clear indication about the space that each LFP connection needs in the installation, please have a look at the images below.

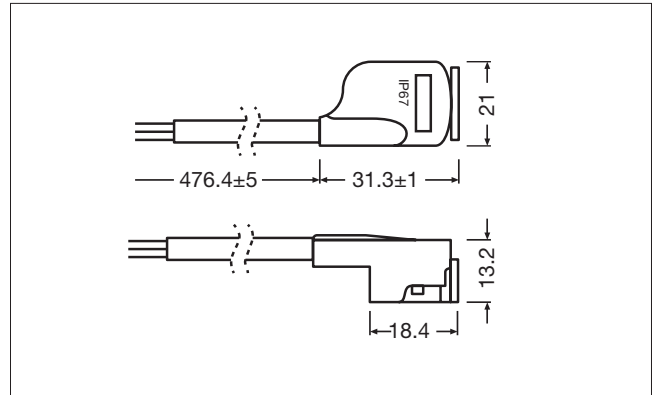

CONN-FLEX-IP67-2P

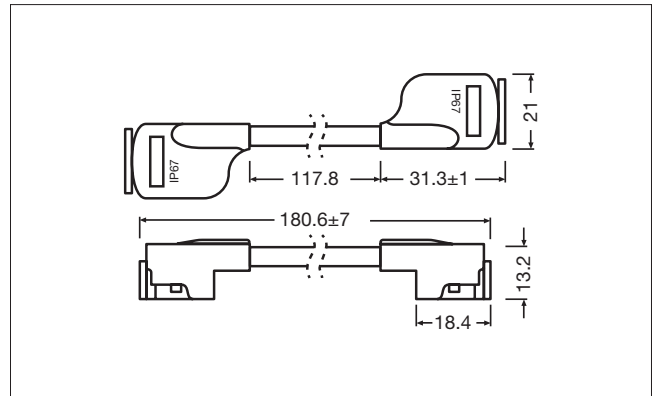

JUMPER-FLEX-IP67-2P

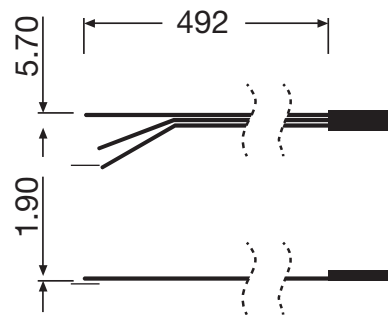

LFP Tunable White with premounted feeders



## 2.3 Assembly

### 2.3.1 Assembly with CONN-FLEX-IP67-2P

1. Components for assembly:
  - LINEARlight FLEX Protect White LED module (LFP2000)
  - Connector CONN-FLEX-IP67-2P
  - ENDCAP-IP67
2. Cut at the first "scissors" symbol.
3. Remove the first 20mm of the white liner on the bottom side.
4. Insert the LED module completely into the connector. Observe the correct polarity (marked information has to be on the same side of connector cable).
5. Ensure that the LED module completely covers the control window.
6. Place the metal part of the connector on a flat surface. Keep the LED module fixed on the surface with one hand. Hold the CONNECTsystem down while pushing the module into the connector with the other hand.
7. Gently press both sides down until you feel both sides close with a click.
8. Take the ENDCAP-IP67 and fill in the provided special silicone (it is enough to slightly cover the bottom side of the endcap).
9. Remove about 20 mm of the white liner.
10. Fully insert the LED module into the endcap.
11. Check if there is glue flowing out of the endcap. If this is the case, clean with a dry cloth.
12. Connect the LED module to the LED driver. Observe the correct polarity (red+/black-). Perform final operating test.

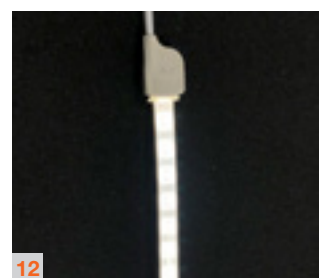
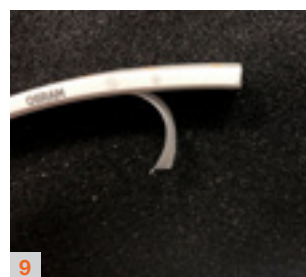
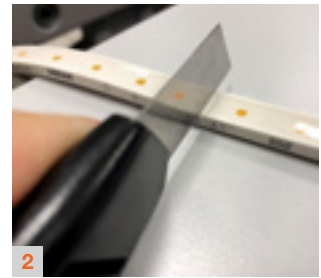
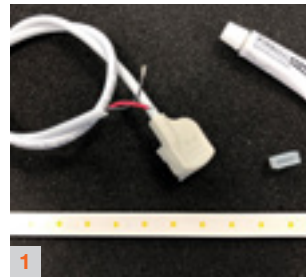

### 2.3.2 Assembly with JUMPER-FLEX-IP67-2P

1. Components for assembly:
  - LINEARlight FLEX Protect White LED modules (LFP2000)
  - JUMPER-FLEX-IP67-2P
2. Cut the LED module as described in paragraph 2.2.1



3. For each connector head of JUMPER-FLEX-IP67-2P, follow the same mounting steps described in paragraph 2.3.1, starting from point 3.



## 2.4 Profile system

### 2.4.1 System overview

We offer two profile system typologies:

#### LTS slim profile

This is a system based on an aluminum profile that has a dedicated design for our LINEARlight FLEX Protect (LFP) products. There are three optics available:

- Transparent ("CLEAR") for those installations where a similar Lambertian radiation pattern is required
- Diffuse ("OPAL-S") for installations where a similar Lambertian radiation pattern and a homogeneous light distribution (no spot) are required
- Diffuse ("OPAL") for installations where a larger radiation pattern (>200°) is required

The table below shows all LTS components and how they can be matched.

#### LTS

Track	Endcap	Cover			Bracket
		LTS-COVER-OPAL-S-2000	LTS-COVER-CLEAR-2000	LTS-COVER-OPAL-2000	LTS-MB MOUNTING BRACKET
LTS-SLIMTRACK-2000	LTS-ENDCAP-COVER-OPAL-S				
	LTS-ENDCAP-COVER-CLEAR				
	LTS-ENDCAP-COVER-OPAL				
	LTS-ENDCAP				

### FX QMx profiles

This is a system based on several aluminum profiles that have the flexibility to cover a huge range of installations.

The system is based on two different platforms:

- **Slim** profiles for applications such as shelves, closets, showcases, cabinet lighting, handrails and stairs
- **Wide** profiles for recessed lighting and architectural integration

Both platforms offer transparent and diffuse optics. The following descriptions show the system naming concept (nomenclature).



### Aluminum profiles

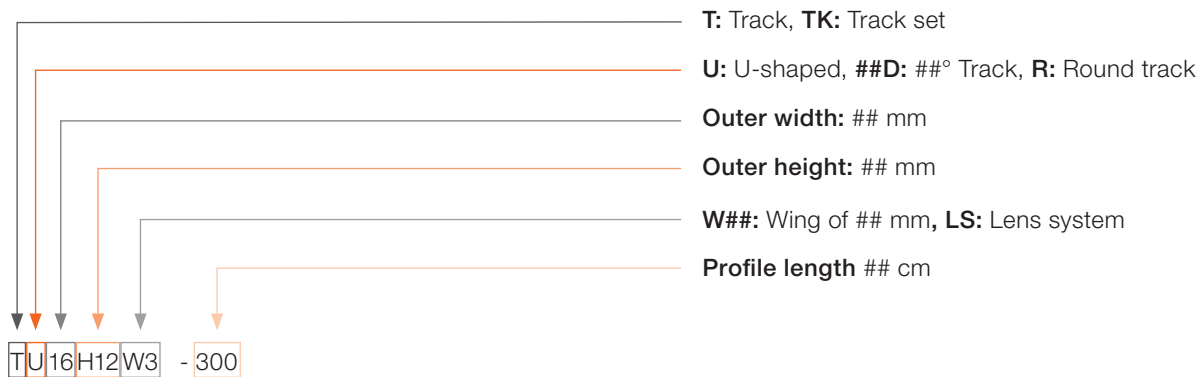

### Covers

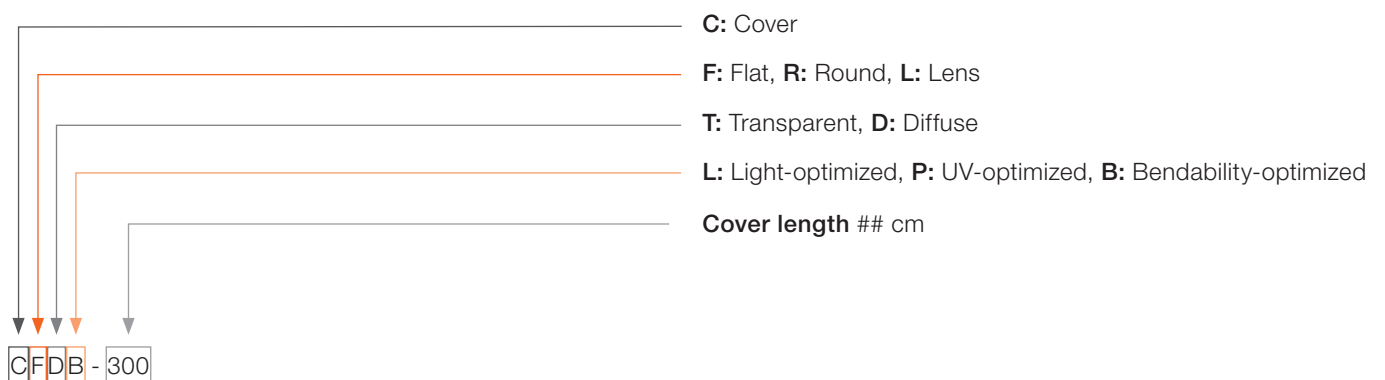

### Endcap

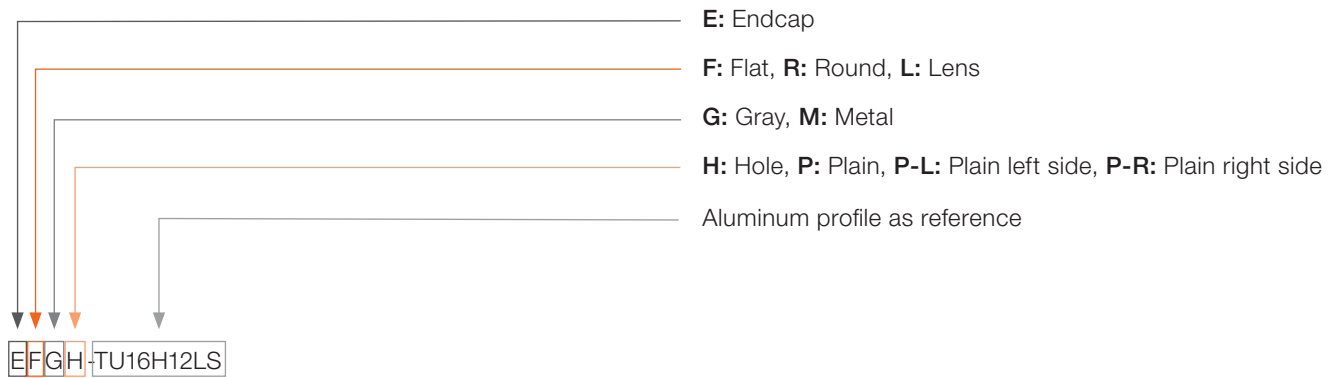

### Mounting bracket

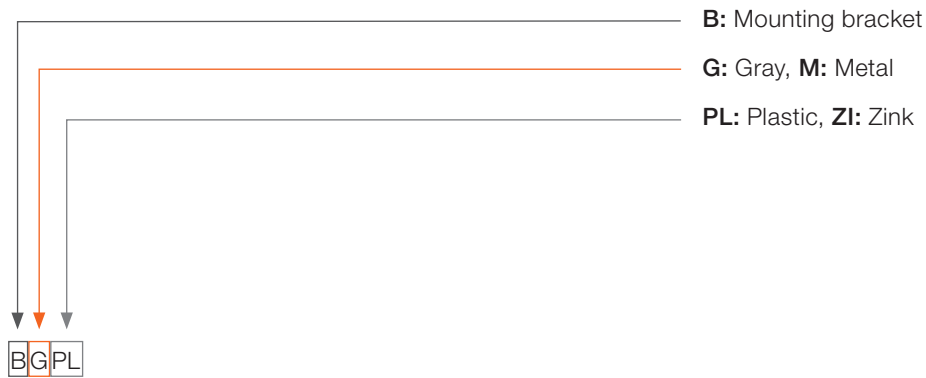

### Mounting spring

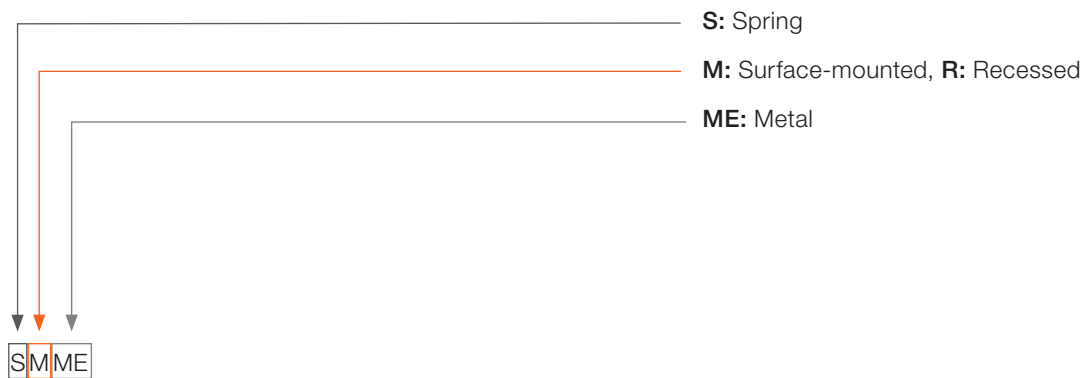

The table below shows all FX-QMS components and how they can be matched.

**FX-QMS**

Aluminum profile	Endcap (with hole)	Endcap (without hole)	Cover			Bracket/ Accessory		
			FX-QMS-G1-CFDB-300	FX-QMS-G1-CFTL-300	FX-QMS-G1-CLT-300	FX-QMS-G1-BMZI-DIV1	ADJUSTABLESLIMBRACKET	FX-QMS-G1-BMZI-T45D19H19
FX-QMS-G1-TU15H6-300	FX-QMS-G1-EFGH-TU15H6	FX-QMS-G1-EFGP-TU15H6	■	■		■	■	
FX-QMS-G1-TU15H6W3-300	FX-QMS-G1-EFGH-TU15H6W3	FX-QMS-G1-EFGP-TU15H6W3	■	■		■	■	
FX-QMS-G1-TU16H12LS-300	FX-QMS-G1-EFGH-TU16H12LS	FX-QMS-G1-EFGP-TU16H12LS	■	■		■	■	
	FX-QMS-G1-ELGH-TU16H12LS	FX-QMS-G1-ELGP-TU16H12LS			■	■	■	
FX-QMS-G1-TU16H12-300	FX-QMS-G1-EFGH-TU16H12LS	FX-QMS-G1-EFGP-TU16H12LS	■	■		■	■	
	FX-QMS-G1-ELGH-TU16H12LS	FX-QMS-G1-ELGP-TU16H12LS			■	■	■	
FX-QMS-G1-TU16H12W3-3	FX-QMS-G1-EFGH-TU16H12W3	FX-QMS-G1-EFGP-TU16H12W3	■	■		■	■	
FX-QMS-G1-T45D19H19-300	FX-QMS-G1-EFGH-T45D19H19	FX-QMS-G1-EFGP-T45D19H19					■	
FX-QMS-G1-TR19H16-300	FX-QMS-G1-EFGH-TR19H16	FX-QMS-G1-EFGP-TR19H16	■	■		■		■

**Note:**

For any other information related to the FX-QMS accessories, please go to [www.inventronics-light.com](http://www.inventronics-light.com)

**Notes:**

With the FX-QMS aluminum profile system, the accessories CONN-FLEX-IP67-2P and the JUMPER-FLEX-IP67-2P cannot be installed within the profile. Therefore, these accessories should be installed as shown in the image on the right, with the connector placed externally.

With FX-QMS-G1-TU15H6-300 and FX-QMS-G1-TU15H6W3-300, the two covers FX-QMS-G1-CFDB-300 and FX-QMS-G1-CFTL-300 cannot be installed with LFP products. In fact, these aluminum profiles are too slim and therefore it is not possible to enable a mechanical fixation of both covers with these LED modules.



The table below shows all FX-QMW components and how they can be matched.

**FX-QMW**

Aluminum profile	Endcap 1	Endcap 2	Cover			Bracket/Accessory				
			FX-QMW-G1-CRD-300	FX-QMW-G1-CFDB-300	FX-QMW-G1-CFTP-300	FX-QMW-G1-BGPL-DIV	ADJUSTABLEWIDEBRACKET	FX-QMW-G1-SMME-DIV1	FX-QMW-G1-SRME-DIV1	FX-QMW-G1-XCLPL1-DIV1
FX-QMW-G1-TU26H10-300	FX-QMW-G1-ERGP-TU26H10		■			■	■	■		
FX-QMW-G1-TU26H25-300	FX-QMW-G1-EFGP-TU26H25			■		■	■	■		
	FX-QMW-G1-ERGP-DIV1	FX-QMW-G1-EFGP-TU26H25	■			■	■	■		
FX-QMW-G1-TU26H25W2-300	FX-QMW-G1-EFGP-TU26H25W2			■	■				■	
	FX-QMW-G1-ERGP-DIV1	FX-QMW-G1-EFGP-TU26H25W2	■						■	
FX-QMW-G1-TU26H25W10	FX-QMW-G1-EFGP-TU26H25W10			■	■				■	
	FX-QMW-G1-ERGP-DIV1	FX-QMW-G1-EFGP-TU26H25W10	■						■	
FX-QMW-G1-TK30D46H27-300	FX-QMW-G1-EFGP-L-TK30D46H27	FX-QMW-G1-EFGP-R-TK30D46H27	■	■						■

**Note:**

For any other information related to the FX-QMW accessories, please go to [www.inventronics-light.com](http://www.inventronics-light.com)

**Notes:**

Please consider that for the following two profiles:  
 – a) FX-QMW-G1-TU26H10-300  
 – b) FX-QMW-G1-TK30D46H27-300  
 the accessories CONN-FLEX-IP67-2P and JUMPER-FLEX-IP67-2P can be installed within the profile only without the cover. Otherwise they have to be placed externally as shown in the image below:

The accessories CONN-FLEX-IP67-2P and JUMPER-FLEX-IP67-2P can be integrated into the following profiles:

- a) FX-QMW-G1-TU26H25-300
- b) FX-QMW-G1-TU26H25W2-300
- c) FX-QMW-G1-TU26H25W10





### 2.4.2 LTS-MB (mounting bracket)

It is recommended to use a mounting bracket every 0.5 to 0.8 m, i.e. for one OSRAM SLIM TRACK System with a total length or 2 m, four mounting brackets are sufficient.



#### Use as a connector

It is also possible to use the LTS-MB as a connector for two or more OSRAM SLIM TRACK Systems.

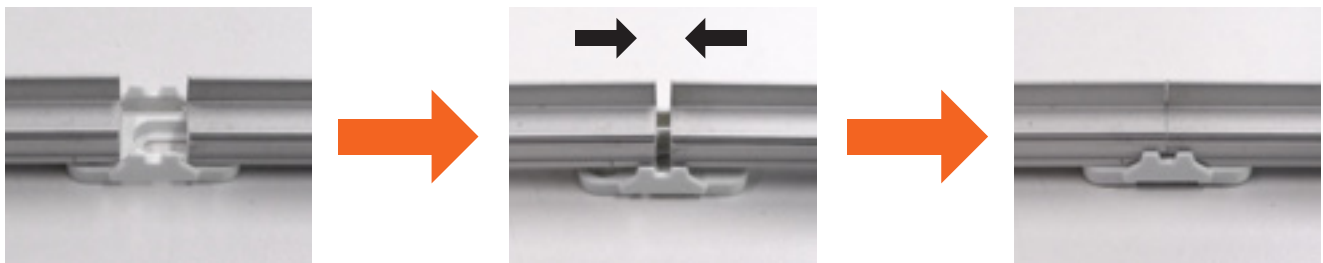

Place the two SLIM TRACK Systems into the mounting bracket

Slide in the SLIM TRACK Systems

Completed connection of two SLIM TRACK Systems

### 2.4.3 FX-QMS/QMW-B/S (mounting bracket and springs)

It is recommended to use one of the mounting brackets below at every 0.3 to 0.4 meters.

- FX-QMS-G1-BMZI-DIV1
- FX-QMS-G1-BMZI-T45D19H19
- ADJUSTABLESLIMBRACKET
- FX-QMW-G1-BGPL-DIV
- ADJUSTABLEWIDEBRACKET

For example, an FX-QMS-G1-TU16H12LS-300 with a total length of 3m needs nine brackets for a reliable installation.

For surface-mounted and recessed installation where springs are the best suitable option to fix the FX-QMW aluminum profiles, it is recommended to use either **three FX-QMW-G1-SMME-DIV1 springs** or **three pairs of FX-QMW-G1-SRME-DIV1 springs** for each meter of aluminum profile.

FX-QMW-G1-SMME-DIV1

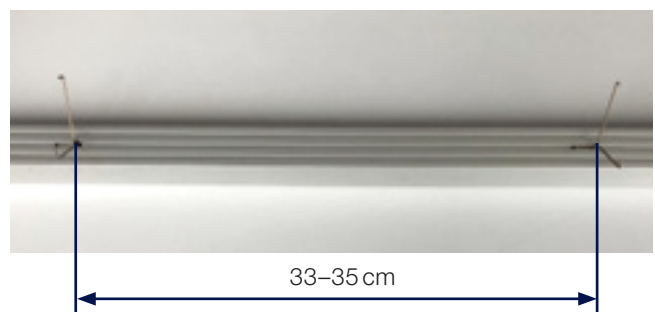

FX-QMW-G1-SRME-DIV1

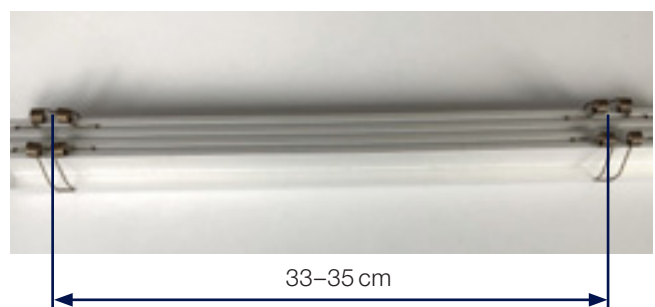

# 3 System connection

## 3.1 Basic steps of system planning

1. Select the suitable LINEARlight FLEX Protect LED module with regard to your application and its requirements (level of light output, LED pitch etc.).
2. Determine the required level of control for the application (dimming, control interface, Tunable White applications etc.).
3. Determine the number of LINEARlight FLEX Protect LED modules and total wattage to be installed.
4. Consider all possible limitations of the setup: Cable lengths (for this, please have a look at the application guide for OPTOTRONIC constant-voltage LED drivers and at the technical documentation available for each OT CV device), thermal load, mechanical forces, ambient conditions and all other factors that may occur in a certain application.

## 3.2 Standard connection

The electrical connection between the secondary side of the OPTOTRONIC LED driver and the LINEARlight FLEX Protect LED module must be IP protected. Therefore, a clamp with appropriate IP protection has to be applied.

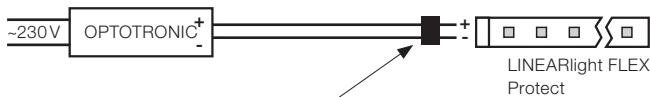

Apply a clamp with an appropriate IP rating

### Note:

For further information, please see the datasheets of the OPTOTRONIC LED drivers.

## 3.3 Parallel and series connection

If multiple LINEARlight FLEX Protect LED modules are connected to one LED driver, they must be connected in parallel as shown in the picture below.

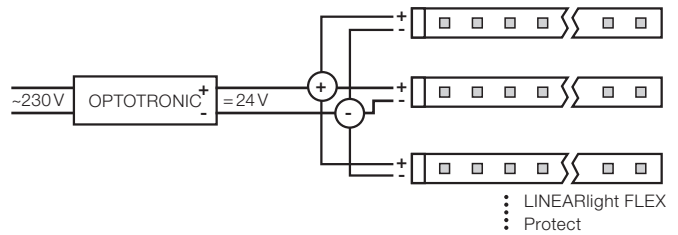

Series connection, made possible by using JUMPER-FLEX-IP67-2P, is allowed. However, the connection of different LED modules to the ECG must be done carefully without exceeding the maximum operable length of LED modules (the product length is a technical information available on each technical datasheet or specification sheet of each LFP product).

### Example:

**LFP2000S-G5-xxxx-05 C** is a 5-m product. A section of 3m can be connected with another one of 1m (4m in total) as shown below:

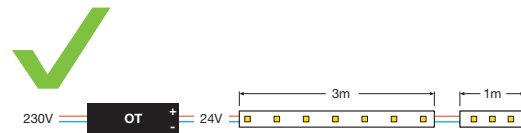

However, more sections **cannot** be connected in series if the sum of their lengths is longer than the maximum operable length of the standard product.

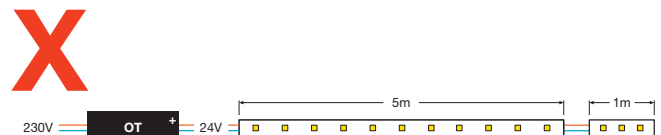
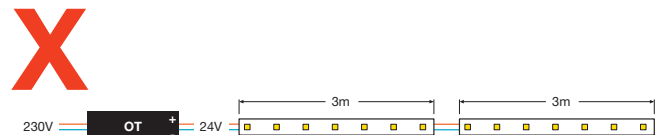

### 3.4 Temperature

For final application, it is important to check if the case temperature  $t_c$  of the product is lower than the maximum declared value. An ambient temperature change during the day (due to, for example, a different sun exposure or the turning on of a heating system) can in fact influence the  $t_c$  value when the LED module is on.

For this reason, it is required to measure the case temperature at the  $t_c$  point in the worst possible conditions of the installation. Where to measure the case temperature  $t_c$  and the respective maximum temperature values are shown below:

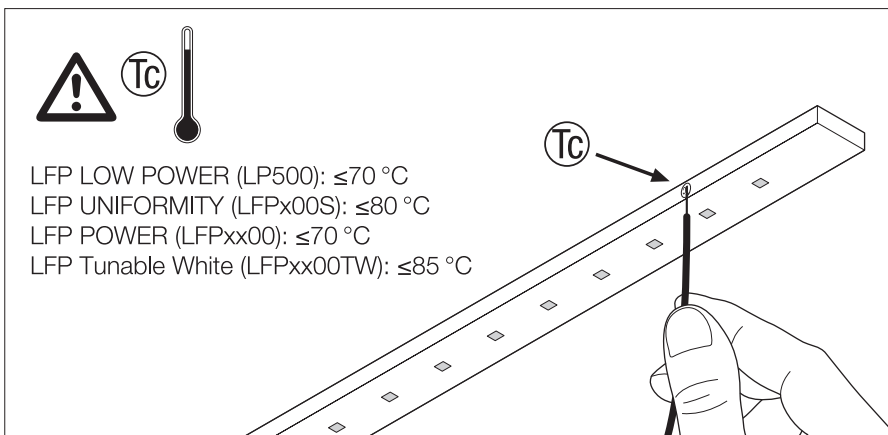

### 3.5 Compatibility with LED drivers

Our OPTOTRONIC CV portfolio is completely compatible with the LINEARlight FLEX portfolio. From an electrical point of view, the matching between the LED drivers and these LED modules has to consider that the power absorption of LFP modules changes with the temperature.

In fact, all the power consumptions defined in the technical documentation of each product is specified for a dedicated  $t_p$  temperature (in  $^{\circ}\text{C}$  and measurable at the  $t_c$  point of the product). When the  $t_p$  decreases, the power absorption increases, and vice versa.

Therefore, in order to select the right LED drivers, the ambient conditions at the installation site of the LED modules must also be considered. The graph below shows the power absorption behaviors at different  $t_p$  levels for all LFP White and Tunable White products<sup>1)</sup>.

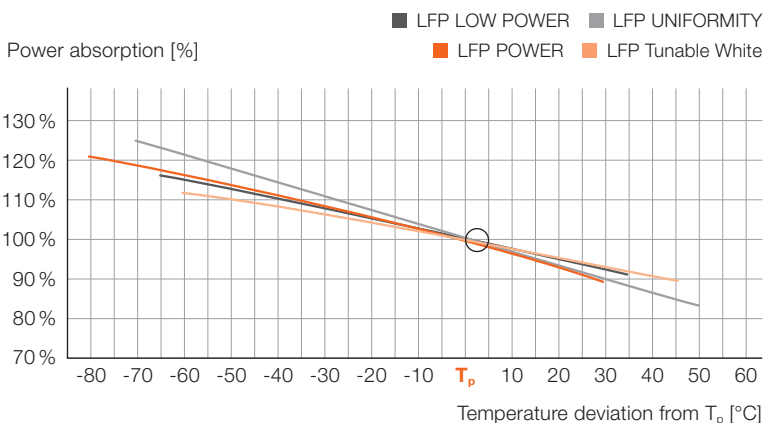

1) The graph gives a first indication of the power absorption behaviour of different LED module families, based on internal evaluation under specific conditions. For a proper system match in the final application, it is suggested to measure the power absorption of the LED module directly on the installation.

Use our contact form

[www.inventronics-light.com/contact-us](http://www.inventronics-light.com/contact-us)



Service contact:

**Inventronics GmbH**

Parkring 31-33, 85748 Garching, Germany

[www.inventronics-light.com](http://www.inventronics-light.com)

[support@inventronicsglobal.com](mailto:support@inventronicsglobal.com)

INVENTRONICS is a licensee of ams  
OSRAM. OSRAM is a trademark of ams  
OSRAM.

**inventronics**