

04/2023

Technical application guide
PrevaLED® Cube AC DALI
light engines

OSRAM

Contents

1 Introduction	03	6 Thermal considerations	16
1.1 System overview	03	6.1 Thermal interface material and other accessories	16
1.2 Nomenclature	04	6.2 Cooling systems and heat sinks	16
2 Optical considerations	05	6.3 t_c point location and temperature measurement	17
2.1 Light distribution	05	6.3.1 Thermocouple	17
2.2 Reflector design	05	7 Lifetime and thermal behavior	19
2.3 Color temperature	06	7.1 Cooling	19
2.4 Color rendering	06	7.2 Luminous flux as a function of temperature	19
2.5 Spectral distribution	06	7.3 Thermal protection mechanism	19
3 Ingress protection	07	7.4 Lifetime as a function of temperature	20
4 Electrical considerations	07	8 Mechanical considerations	21
4.1 Wiring information	07	8.1 Outline drawing	21
4.2 Insulation requirements	08	8.2 3D drawing	21
4.3 Inrush current and system installation	08	8.3 Mechanical protection of the light engine	21
4.4 Electrostatic discharge (ESD)	08	8.4 Mounting	21
4.5 Controllability	08	8.5 Protection from corrosion	21
4.6 Power as a function of voltage	08	9 Norms and standards	22
5 DALI	09		
5.1 Introduction	09		
5.2 Integrated DALI functions	09		
5.2.1 Touch DIM®	09		
5.2.2 Corridor Function and parametrization options	11		
5.2.3 SMART GRID function	13		
5.3 Digital programming	14		
5.4 DC operation	14		
5.5 Parametrization by Tuner4TRONIC® software	14		

Please note:

All information in this guide has been prepared with great care. INVENTRONICS, however, does not accept liability for possible errors, changes and/or omissions. Please check www.inventronics-light.com or contact your sales partner for an updated copy of this guide. This technical application guide is for information purposes only and aims to support you in tackling the challenges and taking full advantage of all opportunities the technology has to offer. Please note that this guide is based on own measurements, tests, specific parameters and assumptions. Individual applications may not be covered and need different handling. Responsibility and testing obligations remain with the luminaire manufacturer/OEM/application planner.

1 Introduction

1.1 System overview

The brightness levels of today's LEDs are opening the door for the use of LEDs in general lighting applications that require high lumen output levels. Building an LED-based luminaire poses a new set of technical challenges, among them new optical requirements, providing adequate thermal management for stable operation and dealing with the ever-improving performance of LEDs. Nevertheless, LED technology also offers an unknown wealth of possibilities, providing access to unprecedented levels of performance and new ways of integration.

Our PrevaLED® family of LED light engines addresses the challenges of LED-based lighting while providing users with great performance and flexibility at the same time. Enabled by the application of LED technology, PrevaLED® is aiming to push the envelope of what is possible in terms of performance and simplicity.

The PrevaLED® Cube AC DALI series of light engines is ideally suited for use in a broad range of wide-reflector-based applications such as downlights.

PrevaLED® Cube AC DALI is an innovative solution. It incorporates four main features into one light engine:

- 1 LED module
- 2 LED driver
- 3 DALI dimmability
- 4 SMART GRID

The luminaire manufacturer benefits from reduced complexity inside the luminaire. The reduced amount of components reduces the logistical efforts and eases the manufacturing process. In addition, it enables the development of innovative miniaturized designs. The dimming behavior is on an excellent level with a dimming range from 100 % down to 1 %.



Dummy of a PrevaLED® Cube AC DALI light engine

PrevaLED® Cube AC DALI light engines provide several specific benefits:

- The first LED light engine on the market providing all functions and advantages of the DALI 2 standard!
- With the LED sources and the electronic control circuitry placed on the same board and packaged into a unique compact design, they offer an integrated system solution.
- Little design-in effort is required due to the integration of the electronic control circuitry into the light engine, offering a new level of simplicity.
- High performance in terms of both the complete system efficiency and the quality of light (small color deviation, no recognizable light modulation).
- Due to the low height of only 18.6mm as well as the established footprint and means of mechanical fixation, a large number of existing accessories (optics, heat sinks etc.) can be easily adapted.
- All in all, PrevaLED® Cube AC DALI light engines not only offer a low threshold for the adaption of LEDs, but also a significant increase in flexibility for applications already adapted to LED technology.

At present, the PrevaLED® Cube AC DALI series is available as a 1 100-lm, 2 000-lm or 3 000-lm package in two light colors (3000 K and 4000 K) with a color reproduction of CRI > 80.

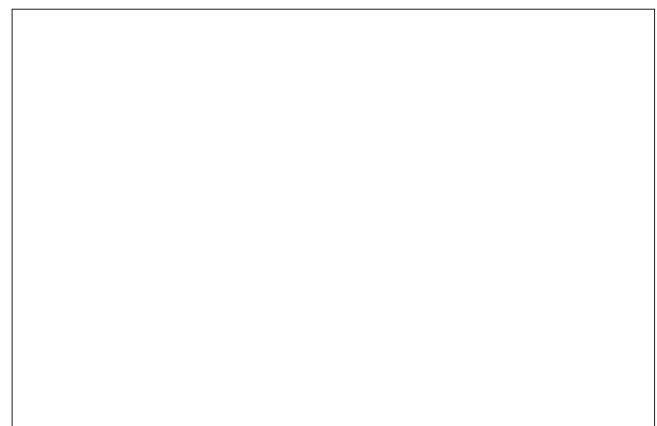

Move me!
Movable 3D PrevaLED® Cube AC light engine
(works with Adobe Acrobat 7 or higher)

1.2 Nomenclature

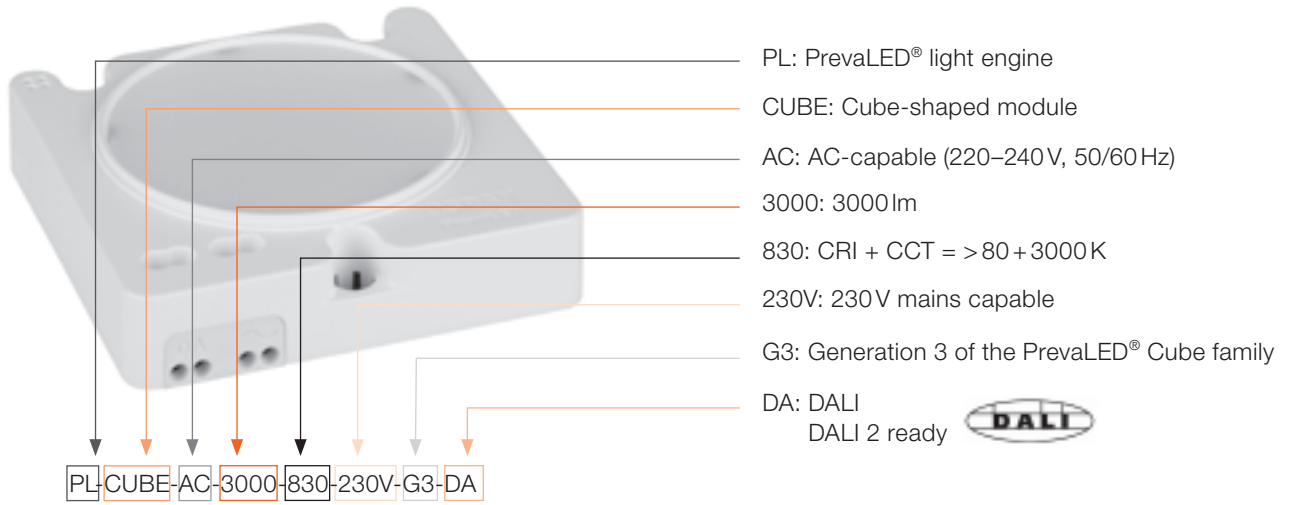

2 Optical considerations

PrevaLED® Cube AC light engines can be applied in diffuse wall-mounted and ceiling-mounted luminaires without the need for further optical accessories.

2.1 Light distribution

The light distribution of PrevaLED® Cube AC light engines is shown below. They create a beam angle of 110° FWHM.

Light distribution curve

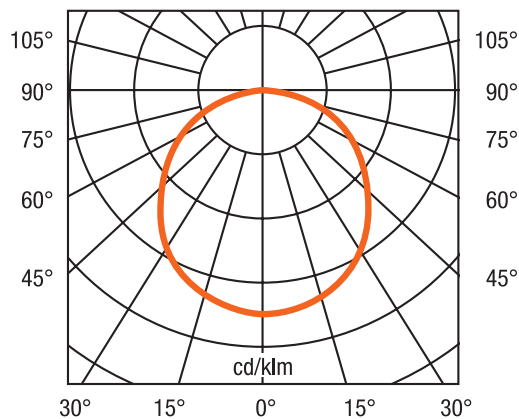

The light-emitting surface of the light engines is covered by a diffuser to ensure a homogeneous, smooth light distribution.

2.2 Reflector design

PrevaLED® Cube AC light engines can also be used with secondary optics. As their optical interface has the same dimensions as common downlight modules on the market, they can be combined with available off-the-shelf secondary optics.

Support for optics can be found, for example, at the following suppliers:

Jordan Reflektoren GmbH & Co. KG

Schwelmer Strasse 161, 42389 Wuppertal, Germany
+49 202 60720
info@jordan-reflektoren.de
www.jordan-reflektoren.de

ACL-Lichttechnik GmbH

Hans-Boeckler-Strasse 38A, 40764 Langenfeld, Germany
+49 2173 9753 0
info@reflektor.com
www.reflektor.com

Jordan Luxar GmbH & Co. KG

Schneiderstrasse 76 d, 40764 Langenfeld, Germany
Tel.: +49 (0)2173 279-0, Fax: +49 (0)2173 279-250
sales@jordan-luxar.de
www.jordan-luxar.de

Almeco S.p.A.

Via della Liberazione, 15, 20098 San Giuliano Milanese (Mi), Italy
+39 02 988963 1
info.it@almecogroup.com
www.almecogroup.com

Nata Lighting Co., Ltd.

380 Jinou Road, Gaoxin Zone, Jiangmen City, Guangdong, China
+86 750 377 0000
info@nata.cn
www.nata.cn

Widegerm Lighting Ltd.

Flat A, 3/F., Tak Wing Ind. Building
3 Tsun Wen Rd. Tuen Mun, N.T., Hong Kong
+85 224 655 679
henry@widegerm.com.hk
www.widegerm.com.hk

We provide mechanical (3D files) and optical simulation data (ray files) to support customized reflector designs. Ray file data and mechanical files are available for download via the "Tools & Services" portal at www.inventronics-light.com.

2.3 Color temperature

The PrevaLED® Cube AC DALI series is currently available in 3000K and 4000K. The color coordinates within the CIE 1931 color space are given below.

Initial color values of the CCT

	3000K	4000K
C_x	0.439	0.387
C_y	0.405	0.384

Within each available color temperature, the PrevaLED® Cube AC DALI series provides a maximum color variation of three threshold value units (MacAdam steps). The following diagram shows these threshold values within the CIE 1931 color space.

Color coordinates

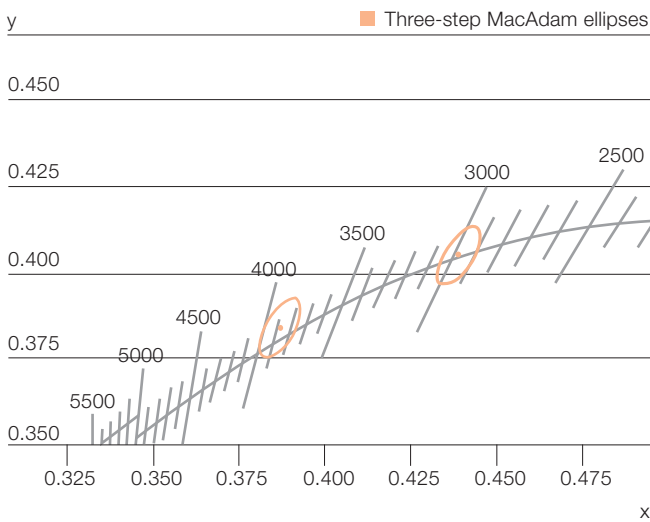

2.4 Color rendering

PrevaLED® Cube AC DALI light engines provide a color rendering index (CRI) of > 80. The table below shows the individual R_a values from R1 to R14 for the available color temperatures.

R_a values

	General CRI	Dusky pink	Mustard yellow	Yellowish green	Light green	Turquoise	Azure	Aster violet	Lilac violet	Red, saturated	Yellow, saturated	Green, saturated	Blue, saturated	Pink, skin color	Leaf green
	R _a	R1	R2	R3	R4	R5	R6	R7	R8	R9	R10	R11	R12	R13	R14
CCT = 3000K	85	83	90	95	84	82	85	89	70	22	75	83	65	85	97
CCT = 4000K	83	81	89	96	83	81	86	86	64	16	75	82	71	83	98

2.5 Spectral distribution

The typical spectral distribution of PrevaLED® Cube AC light engines is shown in the following diagram.

Wavelength spectrum

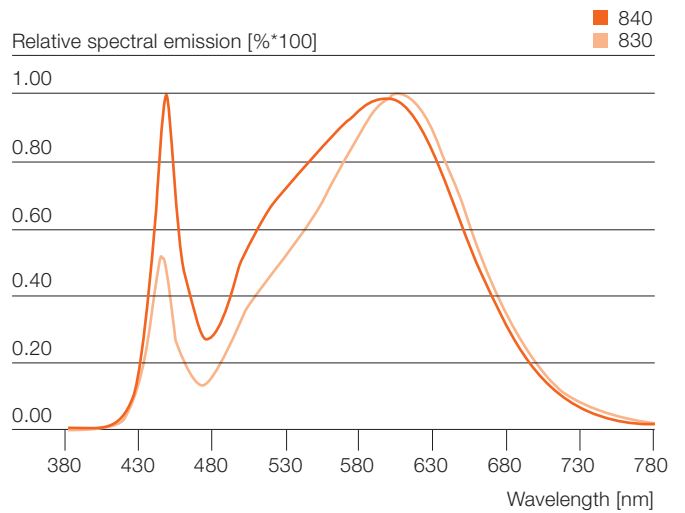

3 Ingress protection

PrevaLED® Cube AC DALI light engines have an ingress protection rating of IP20. Please ensure that the housing of your luminaire provides the ingress protection required for your application.

For further information, please have a look at the technical application guide “IP codes in accordance with IEC 60529”, which can be downloaded at www.inventronics-light.com.

4 Electrical considerations

4.1 Wiring information

PrevaLED® Cube AC DALI light engines can be directly connected to mains voltage (220–240V, 50/60Hz).

The used input clamps can handle solid or flexible wire with a cross-section of 0.2 to 0.75 mm² (AWG 24–18). The use of solid wire is recommended.

Wire preparation

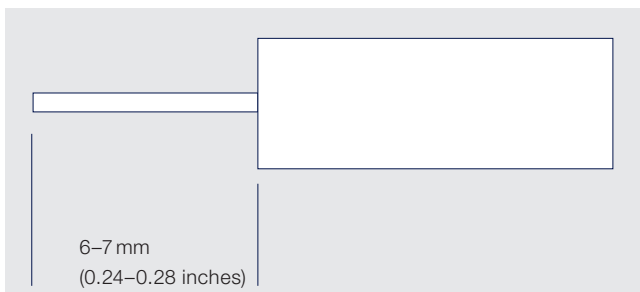

Please insert the wires in 0° orientation to the PCB.

Notes:

- The connector is designed for three poke-in and release cycles.
- Due to the fact that you are dealing with mains voltage, you must not hot-plug the light engine.
- The installation of LED light engines needs to be carried out in compliance with all applicable electrical and safety standards. Only qualified personnel should be allowed to perform installations.



Solid wire:
Plug directly.



Flexible wire:
1. Lightly press the push button of the connection clamp.
2. Insert the flexible wire.

To press/release the clamps, please use an operating tool (Wago type: 206-860) or a small screwdriver.

4.2 Insulation requirements

PrevaLED® Cube AC DALI light engines can be used in class I luminaires without further action. The creepage distance and clearance are fulfilled.

In class II luminaires, additional care needs to be taken only in the area of the input connector. Between connection wires with basic insulation and touchable metal parts or the heat sink, a second insulation layer is required. The light engine itself has double/reinforced insulation.

4.3 Inrush current and system installation

Due to their electronic construction, PrevaLED® Cube AC DALI light engines have a minimum inrush current. In system installations, you can connect the following numbers of PrevaLED® Cube AC DALI light engines to circuit breakers (e.g. B10 etc.) with different characteristics.

- B10: 51 pcs
- B16: 84 pcs
- C16: 142 pcs

4.4 Electrostatic discharge (ESD)

It is not necessary to handle PrevaLED® Cube AC DALI light engines in electrostatic protected areas (EPAs).

To protect a PrevaLED® Cube AC DALI light engine from electrostatic damage, do not open it. The light engine fulfills the requirement of the immunity standard IEC/EN 61547.

4.5 Controllability

PrevaLED® Cube AC DALI light engines are dimmable via the DALI interface in a range of 100% to 1%. In order to protect the light engine from damage, please do not use phase-cut dimmers.

4.6 Power as a function of voltage

The nominal voltage of the light engine is 230V. The operation range is 220–240V. For voltage variations, the light engine is tested according to IEC/EN 61000-3-3. Please note that the power of the light engine changes over the voltage range. Please have a look at the diagrams below for the power as a function of voltage.

PrevaLED® Cube AC DALI 3000lm

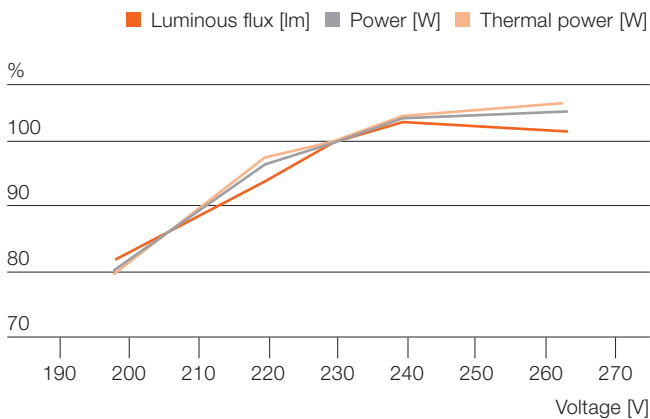

PrevaLED® Cube AC DALI 2000lm

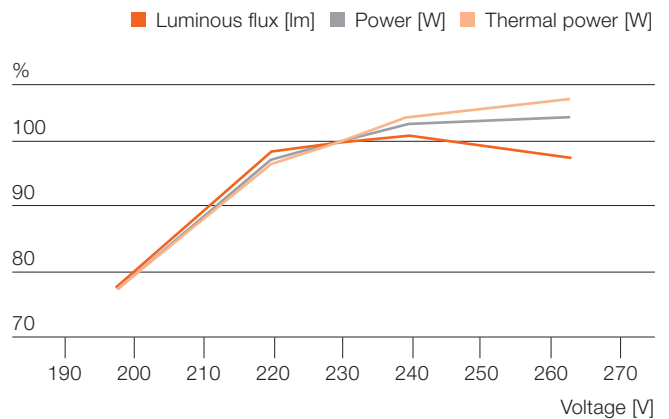

PrevaLED® Cube AC DALI 1100lm

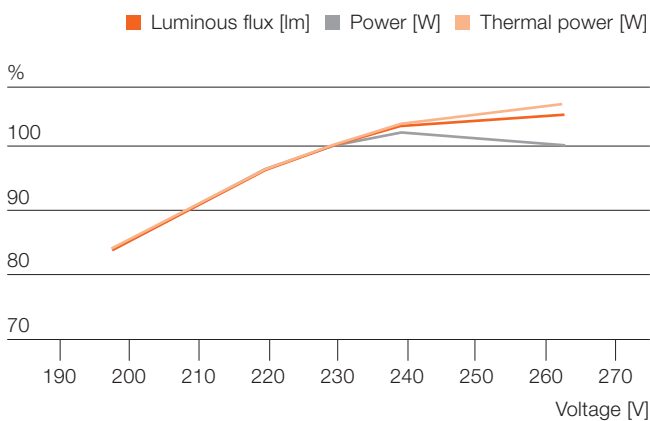

5 DALI

5.1 Introduction

Your interface to the future

DALI devices for intelligent lighting solutions are powerful, efficient and multifunctional.

Creating fascinating settings with light

With the right lighting solution, one can express one's individuality in various ways and perform many different tasks: rooms are brought to life with ease, general safety is increased and the quality of workplace illumination is improved. Our sophisticated and reliable solutions meet all these requirements and, thanks to state-of-the-art lighting control, achieve the highest levels of energy efficiency and individuality. Moreover, they also provide an optimal price-performance ratio while covering a wide spectrum – from simple applications to complex installations with light management systems.

DALI standard and much more

Dimmable digital power supplies with DALI interface provide optimum conditions for achieving the highest possible energy efficiency and flexibility. With the second generation of our DALI devices, we have even surpassed the common DALI standard – with cutting-edge functions that offer unique advantages in a great variety of applications:

- Increase of energy efficiency in storage and production areas in the industrial sector
- Brilliance and individuality in the sales and hospitality sectors
- Flexibility and motivation in office areas
- Multifunctional and flexible wide-area lighting, e.g. in sports halls and parking garages

With our unique digital functions, you can meet today's standards down to the last detail, thus strengthening your position in the lighting market while being best prepared for the requirements of tomorrow. The functions that will be described in detail on the following pages include:

- Touch DIM® function: Comfortable dimming with standard push-buttons
- Corridor Function: Direct use of standard motion sensors
- SMART GRID function: Easy monitoring of lighting systems

5.2 Integrated DALI functions

5.2.1 Touch DIM®



Often it's the easy solutions that save costs and energy. This is also true for the Touch DIM® function: The comfortable dimming of up to 20 light engines, e.g. in conference rooms or single offices, is controlled via standard push-buttons and therefore keeps investment costs low. Connected to mains voltage, each action is triggered by short and/or long push-button pulses. In combination with a Touch DIM® sensor (see also page 10), daylight can also be used, resulting in an additional energy saving.

The plus of the Touch DIM® function

The Touch DIM® function allows for free parametrization of threshold values. In a single office, for example, the lighting can be completely switched off during lunch breaks thanks to the unique stand-by operation. No other DALI device on the market offers this feature.

Touch DIM® function flow chart

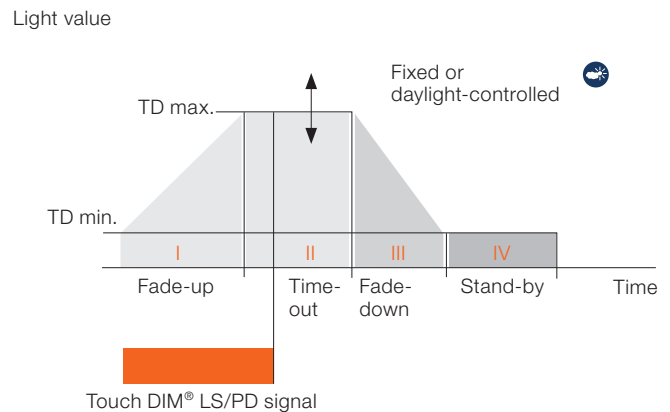

Factory settings:

- Fade-up: 0.7 s
- Time-out: 15 min
- Fade-down: 32 s
- Stand-by: 5 s
- TD min.: 1 %

Sensors for the Touch DIM® function

The sensor Touch DIM® LS/PD LI is a light and presence sensor for luminaire integration. It is also available as a light sensor only (Touch DIM® LS LI) or as a presence and motion sensor with sensor extension (Touch DIM® PD LI 2P WOS).



Touch DIM® LS/PD LI sensor



Touch DIM® LS LI sensor



Touch DIM® PD LI 2P WOS sensor

Touch DIM® LS/PD LI sensor wiring diagram

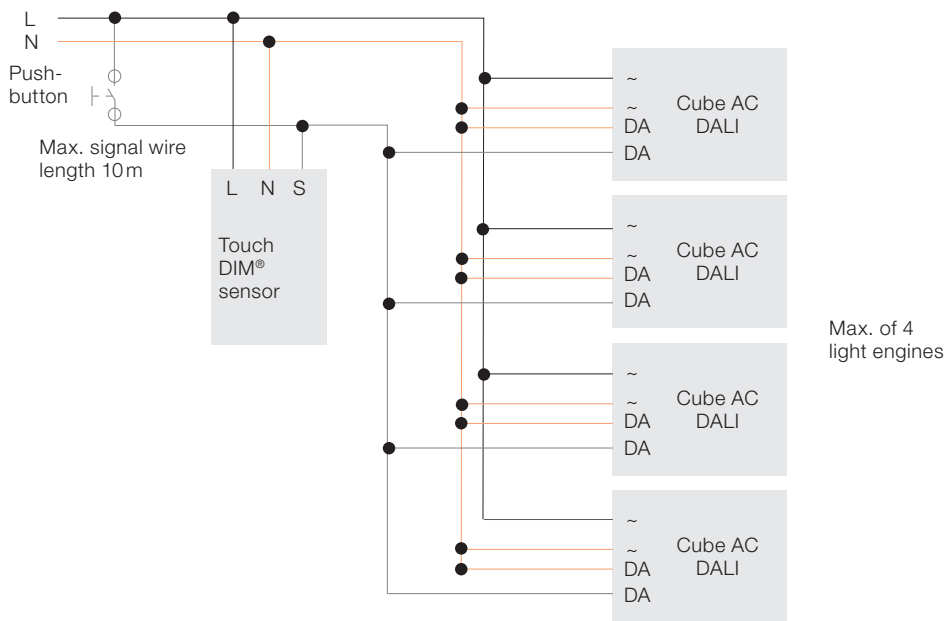

Touch DIM® LS/PD LI sensor detection range

Height [m]	a [m]	b [m]
1.8	4.0	2.7
2	4.4	3.0
2.2	4.9	3.3
2.4	5.3	3.6
2.6	5.8	3.9
2.8	6.2	4.2
3	6.7	4.5
3.2	7.1	4.8
3.4	7.6	5.1

Mounting heights above 3.5m do not lead to any significant extension of the detection range

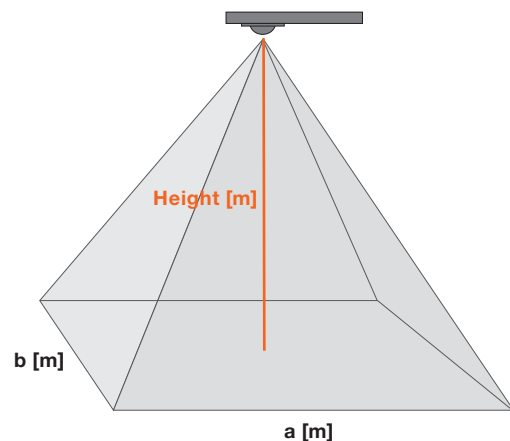

5.2.2 Corridor Function and parametrization options



Description of the Corridor Function

It is possible to connect the PrevaLED® Cube AC DALI directly to commercially available motion sensors. The Corridor Function is triggered by a switching signal, i.e. the voltage of the supply line (220–240V, 50/60Hz) is switched to the DALI control line inputs (DA, DA; see the diagram below). A preset "out-of-the-box" luminous flux program launches upon triggering. This can be individually adjusted via Tuner4TRONIC® and DALI magic. Three light value ranges and six time ranges are available for this purpose.

Several PrevaLED® Cube AC DALI drivers can be synchronized in an installation via the frequency of the mains voltage (50/60Hz). The maximum number of PrevaLED® Cube AC DALI light engines in an installation is only limited by the sum of the inrush current surges from the individual ECGs.

Advantage:

Development of new applications (stairwells, corridors, large storage facilities, ...) with the possibility of saving energy and achieving high energy efficiency.

OSRAM DALI ECG wiring diagram for Corridor Function

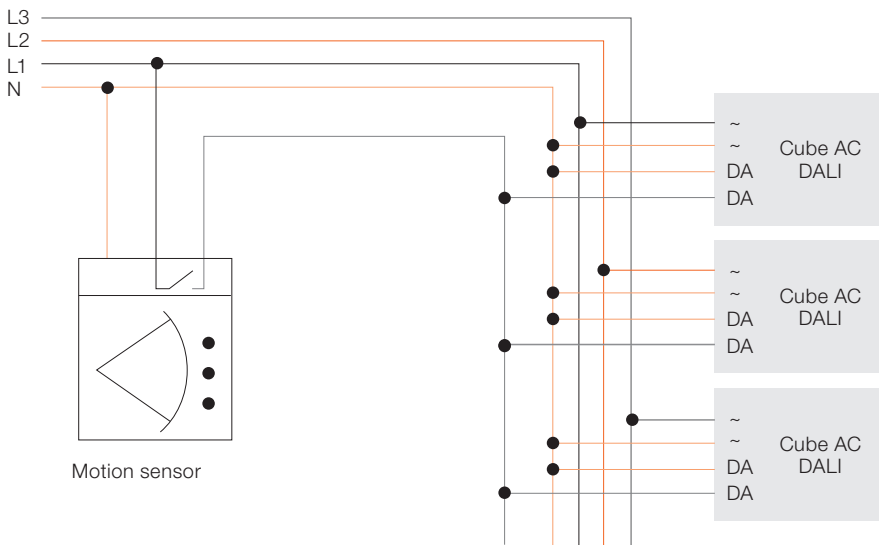

Note:

Default setting of PrevaLED® Cube AC DALI is the Touch DIM® mode. In order to change the parameters or to switch to the Corridor Function, please use the Tuner4TRONIC® software tool. Please note that PrevaLED® Cube AC DALI light engines in Corridor Function can only be combined with other DALI 2 LED modules or control gears.

Corridor Function phasing (general and factory setting)

General curve:

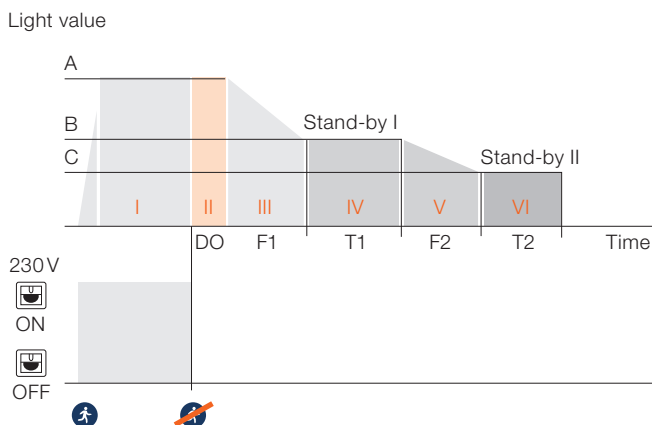

Factory setting:

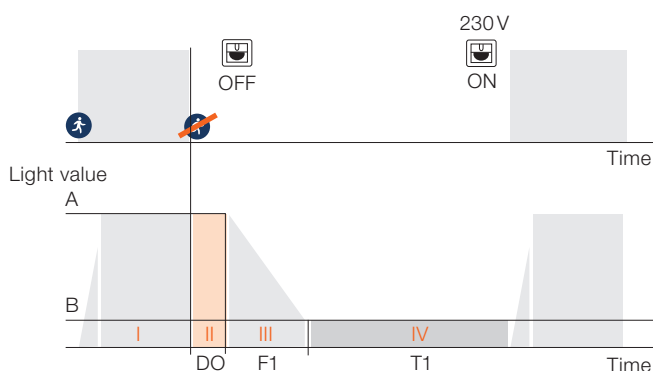

Three dimming ranges (1...100%)

Free parametrization of time (I...VI) using Tuner4TRONIC®

Factory-set parameters:

A: 100%, D0: 120s, F1: 32s
B: 10%, T1: unlimited

Synchronisation of Touch DIM®

If a large number of PrevaLED® Cube AC DALI light engines with Touch DIM® is operated in a system, there is a chance that a PrevaLED® Cube AC DALI light engine will operate out of synchronism with the others (= different dimming level setting or different switching state).

Synchronism can be restored as follows:

Step 1:

Long press of the switch (> 0.5 s) → all the lamps are switched on

Step 2:

Short press of the switch (< 0.5 s) → all the lamps are switched off

Step 3:

Long press of the switch (> 0.5 s) → all the lamps are switched on at minimum dimmer setting and fade up

Step 4:

Double-click (2x within 0.4 s) → store value (optional)

After the first three steps – long-short-long – all PrevaLED® Cube AC DALI light engines will be back in synchronism.

Note:

Touch DIM® is designed for manual control; it is not suitable for a connection to an automation.

Sensor for the Corridor Function

The DUO sensor is a motion detector suitable for ceiling installation. In addition, it can also be used as an intelligent light sensor, i.e. the lighting can be switched off when the amount of daylight increases. In areas where daylight is available, the possible energy savings are therefore significantly higher than with standard motion detectors.



DUO sensor

DUO sensor wiring diagram

Mains 220–240V – 50/60Hz

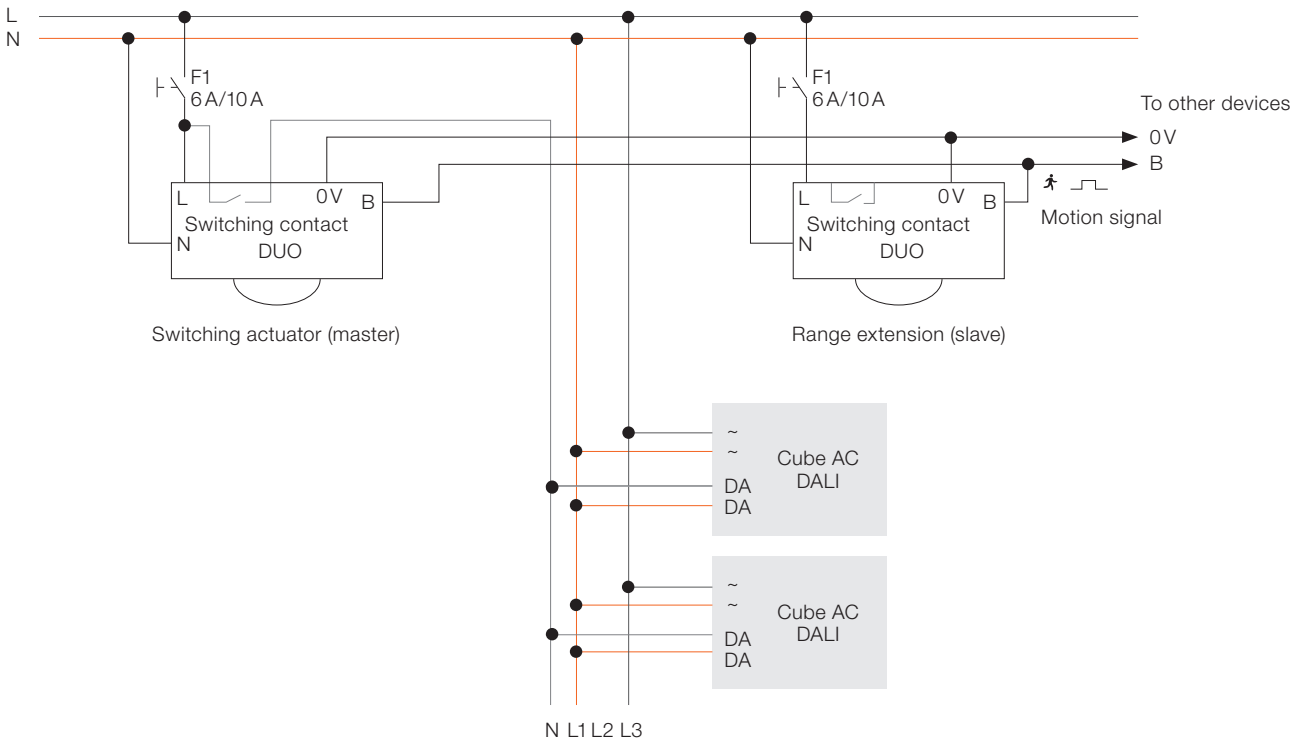

DUO sensor motion detection range (circular)

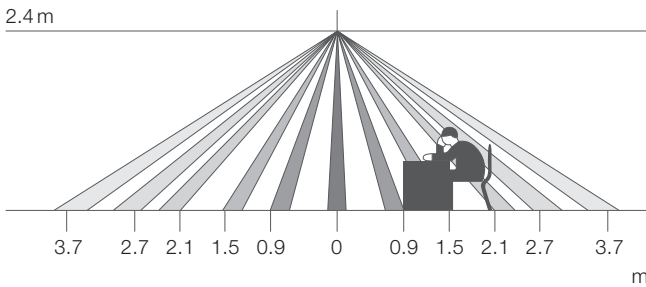

5.2.3 SMART GRID function



With the SMART GRID function, lighting systems can be easily monitored and successfully operated. The function increases the level of service by enabling, for example, the readout of the light sources' operating hours as well as the current operating temperature or the detection of mains overvoltage, thus facilitating the scheduling of service intervals.

Overview of supported SMART GRID functions

Operation time	Supported
Operation temperature*	Not supported
Temperature time integration*	Not supported
Overvoltage detection	Supported
Power consumption	Supported
EOL (end of life)	Not supported

*Not supported means not necessary since the module protects itself.

5.3 Digital programming

PrevaLED® Cube AC DALI light engines can be programmed using the Tuner4TRONIC® (T4T) software together with the hardware programmer “DALI magic”. This software consists of the following software packages:

- T4T – Development
- T4T – Production
- T4T – Dynamic Link Library (DLL)
- T4T – Command Line Version

After registration, the software can be downloaded from the www.myosram.com portal.

For more information on the programming of PrevaLED® Cube AC DALI, please consult the Tuner4TRONIC® manuals.

Light engine programming

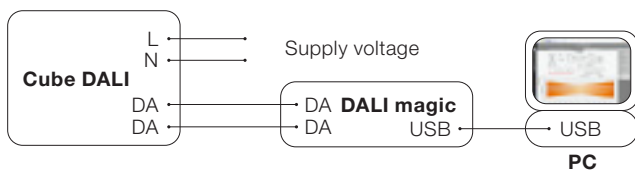

PrevaLED® Cube AC DALI light engines need to be powered during programming. They need to be supplied with the mains input voltage. The low voltage allows for safe programming without the need for additional precautions during production.

5.4 DC operation

PrevaLED® Cube AC DALI light engines are capable to withstand a supply voltage of 300 V_{DC} without causing damage to the light engine. In this operating condition, the light engine will not light up.

This feature enables installations of PrevaLED® Cube AC DALI light engines within the same circuitry as LED modules used for emergency lighting. This causes a significant reduction in wiring effort in the building installation.

5.5 Parametrization by Tuner4TRONIC® software

Like with all other OSRAM DALI devices, it is possible to change, edit and set all DALI parameters of the PrevaLED® Cube AC DALI by use of the Tuner4TRONIC® software tool.

Features such as the Touch DIM® sensor and the Corridor Function remain exactly the same as with all our other devices. Nevertheless, due to the high integration of PrevaLED® Cube AC DALI, a transformation of input parameters for luminous flux has to be made. Tuner4TRONIC® defines current outputs of the secondary side of a typical LED driver. PrevaLED® Cube AC DALI light engines eliminate this interface for the customer as the LED driver and the LED module are integrated.

Therefore, the following data will no longer be visible or useful:

- Maximum rated current
- Operating current
- Minimum rated current

This means it is necessary to reinterpret the data to set a certain maximum operating light level.

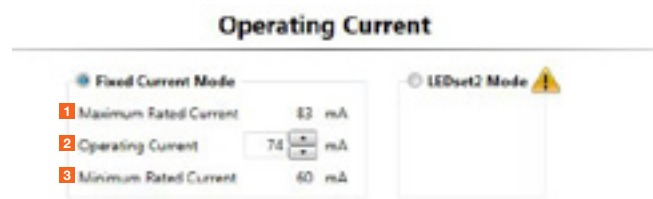

- 1 Maximum module input current
- 2 Nominal module input current
- 3 Minimum module input current

Explanation:

Module input current:

The current input of the module. This parameter can be used to achieve a previously undefined light output. In the factory setting, this current is set to the nominal module input current to achieve the nominal light output under defined performance conditions.

Maximum module input current:

The maximum current that the module can use. PrevaLED® Cube AC DALI: Maximum input LED current = Nominal module input current.

Minimum module input current:

The minimum current that the module can use **and** still achieve a light dimming level of 1 %.

Interactive calculation

To transfer your desired light engine luminous flux into the value which has to be inserted into the Tuner4TRONIC® input field, you can either use the diagrams shown below or insert the flux into the interactive fields below.

PL-CUBE-AC-1100-8x0-230V-G3-DALI

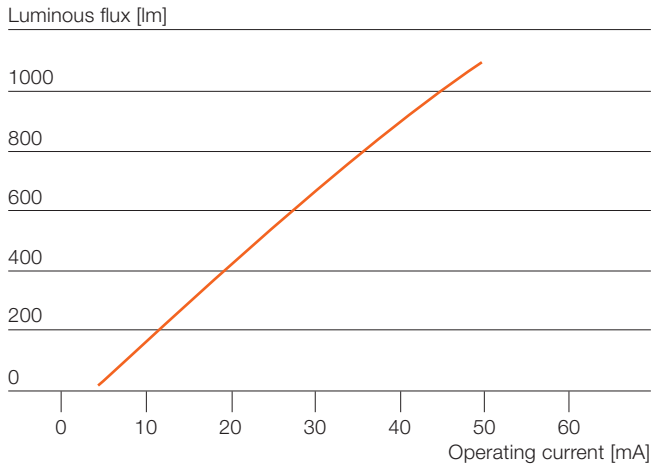

Target luminous flux: lm

Resulting operating current for T4T software (mA):

PL-CUBE-AC-2000-8x0-230V-G3-DALI

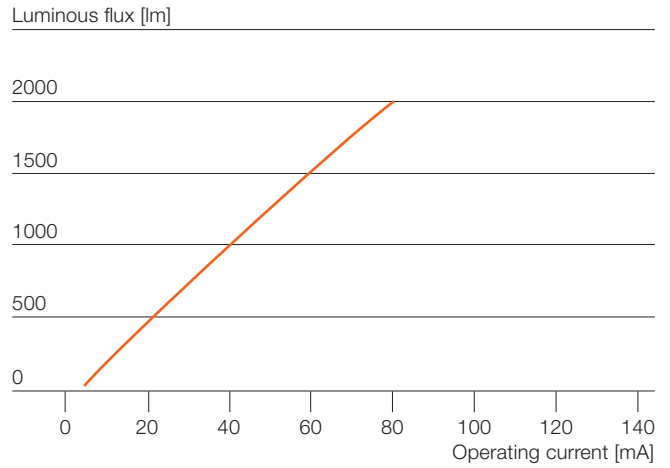

Target luminous flux: lm

Resulting operating current for T4T software (mA):

PL-CUBE-AC-3000-8x0-230V-G3-DALI

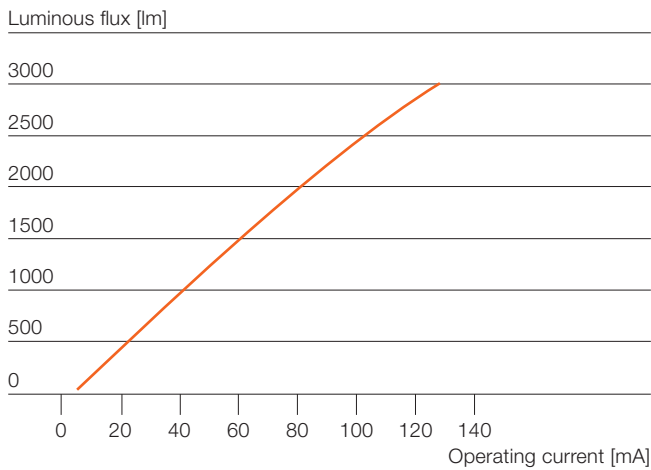

Target luminous flux: lm

Resulting operating current for T4T software (mA):

For further information regarding Tuner4TRONIC®, please see the Tuner4TRONIC® help file which you can find in the software itself.

6 Thermal considerations

The proper thermal design of an LED luminaire is critical for achieving the best performance and ensuring the longest lifetime of all components. Due to the high efficacy of PrevaLED® Cube AC DALI light engines, only a partial amount of the introduced electrical power has to be dissipated through the back of the light engine. The thermal power that has to be dissipated for PrevaLED® Cube AC DALI light engines is given below.

Thermal power values

	Typical thermal power [W] ¹⁾	Max. thermal power [W] ¹⁾	Typical allowable thermal resistance R _{th} [K/W] ²⁾	Max. allowable thermal resistance R _{th} [K/W] ²⁾
PL-CUBE-AC-1100-8XX-230V-G3-DALI	8.2	9.7	5.5	4.7
PL-CUBE-AC-2000-8XX-230V-G3-DALI	12.9	15.5	3.5	2.9
PL-CUBE-AC-3000-8XX-230V-G3-DALI	21.3	25.3	2.1	1.8

6.1 Thermal interface material and other accessories

When mounting a PrevaLED® Cube AC light engine within a luminaire, it is recommended to use thermal interface material (TIM) between the back of the light engine and the luminaire housing or heat sink. It is recommended to use thermal paste. In order to balance possible unevenness, the material should be applied as thinly as possible, but as thickly as necessary. In this way, air inclusions, which may otherwise occur, are replaced by TIM and the required heat conduction between the back of the light engine and the contact surfaces of the luminaire housing is achieved. For this purpose, the planarity and roughness of the surface should be optimized.

The following list is a selection of suppliers of thermal interface materials.

Suppliers of thermal interface materials

Alfatec	www.alfatec.de
Kerafol	www.kerafol.de
Laird	www.lairdtech.com
Bergquist	www.bergquistcompany.com
Wakefield	www.wakefield.com

6.2 Cooling systems and heat sinks

For the selection of a suitable heat sink, several points regarding thermal resistance have to be considered.

The selection is usually carried out along the following necessary steps.

Selection of a heat sink

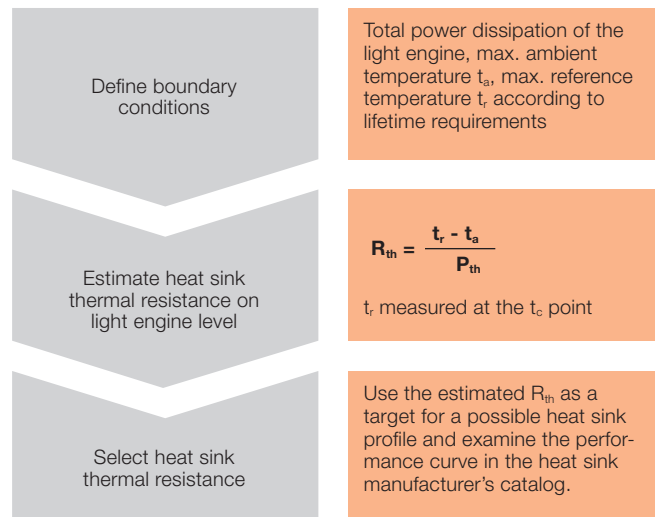

Note: A thermal design must always be confirmed by performing a thermal measurement in steady-state condition.

It is recommended that the whole area of the PCB of a PrevaLED® Cube AC DALI light engine is in contact with the solid material of the heat sink.

1) Value measured at the t_c point at a reference temperature (t_r) = t_p of 70 °C

2) Value measured at an ambient temperature of 25 °C

3) The R_{th} values apply to the light engine incl. the thermal interface material (TIM).

A thermal system always depends on many factors, such as airflow, ambient temperature etc. Please check your entire cooling system by performing a thermal measurement in steady-state condition.

The list below is a selection of suppliers of different cooling solutions.

Suppliers of active and passive cooling systems

Nuventix	www.nuventix.com
Sunon	www.sunoneurope.com
Cooler Master	www.cooler-master.com
AVC	www.avc-europa.de
SEPA	www.sepa-europe.com
Fischer Elektronik	www.fischerelektronik.de
Wakefield	www.wakefield.com
Cooliance	www.cooliance.com

6.3 t_c point location and temperature measurement

The t_c point is the location to check if the chosen cooling solution (heat sink and TIM) is sufficient to ensure the light engine performance. The t_c point is located on the back of the light engine, under the center of the diffuser (see image below).

Location of the t_c point

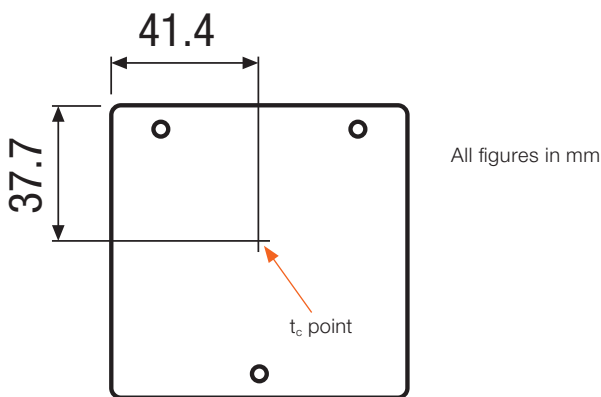

A correct temperature measurement can, for example, be performed with a thermocouple.

6.3.1 Thermocouple

Use a thermocouple that can be glued onto the light engine. Make sure that the thermocouple is fixed with direct contact to the t_c point.

Examples of suitable thermocouples:

K-type thermocouple with miniature connector



Different thermocouples

Illustration	Description	Temperature range [°C]
	PVC-insulated thermocouple	-10 ... +105
	PFA-insulated thermocouple	-75 ... +260
	Sprung thermocouple	-75 ... +260

To measure the temperature and to ensure a good thermal coupling between the light engine and the heat sink, drill a hole into the heat sink and push the thermocouple through it. To ensure a direct contact between the thermocouple and the PCB, it is recommended to glue the thermocouple onto the PCB (e.g. with acrylic glue, e.g. Loctite 3751). The glue shall not influence the thermal coupling.

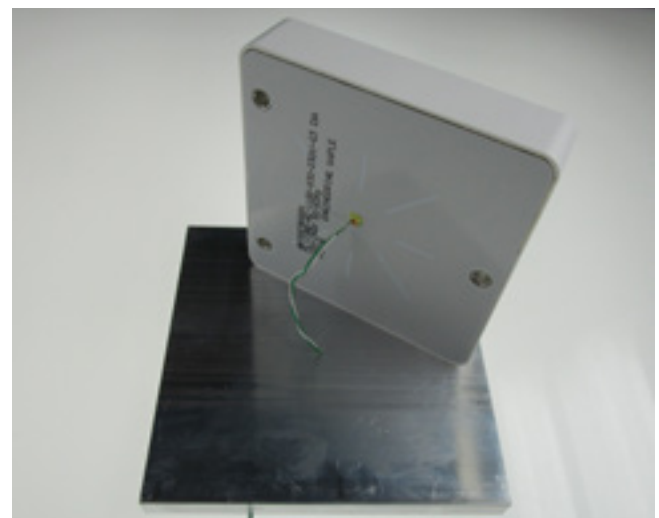

Mounting of a thermocouple through a hole in the heat sink

It is also possible to use a sprung thermocouple. A suitable type is: Electronic Sensor FS TE-4-KK06/09/2m. Please note that a good thermal contact between the thermocouple and the PCB is required. Please refer to the data-sheet and the application guideline of the manufacturer to ensure correct handling.

Another possible way is to create a small groove along the top surface of the heat sink.

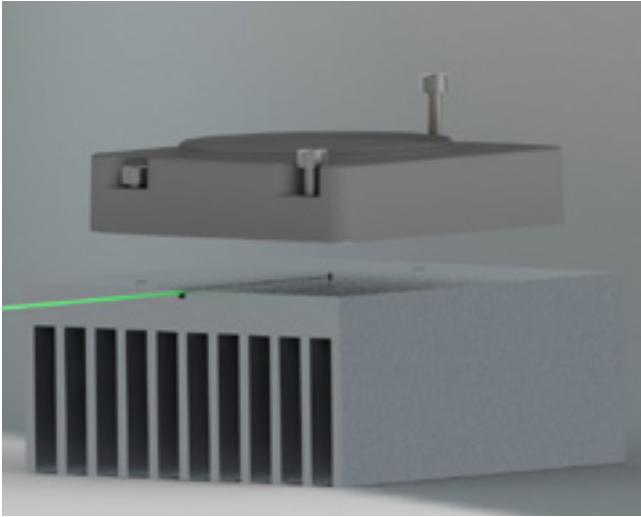

Mounting of a thermocouple by means of a groove

Note: Please keep in mind that you need a direct contact between the thermocouple and the PCB.

7 Lifetime and thermal behavior

7.1 Cooling

To ensure a safe and reliable operation, the light engine must be attached to a suitable cooling solution (e.g. a heat sink).

7.2 Luminous flux as a function of temperature

The luminous flux of PrevaLED® Cube AC DALI light engines depends on their temperature. 100% of the luminous flux is achieved at the reference temperature of 70 °C ($t_p = 70\text{ °C}$). This temperature has to be measured at the t_c point. If the reference temperature increases, the light output decreases.

The luminous flux changes in relation to the reference temperature according to the following diagram.

7.3 Thermal protection mechanism

To protect the light engine from damage by overheating, a thermal derating has been implemented. The derating starts at a t_c point temperature of $>90\text{ °C}$. Please see the curve in the graph at below left.

Flux as a function of temperature at nominal power

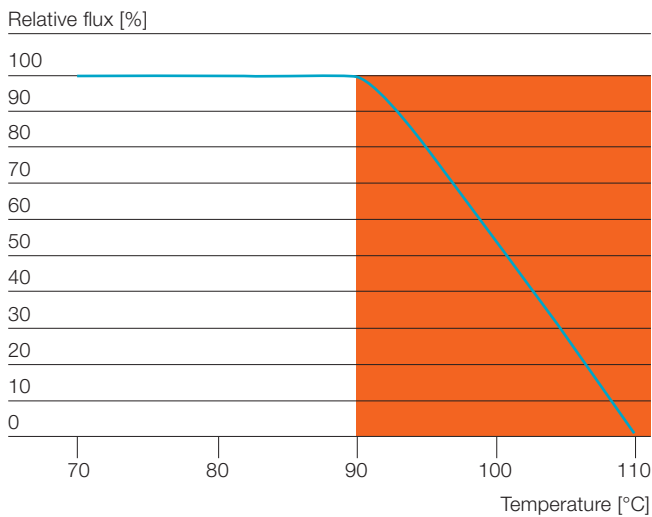

7.4 Lifetime as a function of temperature

For the definition of the lifetime of a light engine, please refer to IEC/PAS 62717, where the following types are defined (examples):

- L0C10 is the lifetime where the light output is 0 % for 10 % of the light engines.
- L70F50 is the lifetime where the light output is ≥ 70 % for 50 % of the light engines. F value includes reduction of lumen output over time including abrupt degradation (flux = 0).
- L70B50 is the lifetime where the light output is ≥ 70 % for 50 % of the light engines. B value includes only gradual reduction of lumen output over time (not the abrupt degradation of flux).

If the performance temperature t_p of 70 °C is maintained, the PrevaLED® Cube light engines have an average lifetime of 50000 hours (L70B50). The maximum temperature measured at the t_c point must not exceed 90 °C.

Note: Higher temperatures lead to a shorter lifetime of the PrevaLED® Cube AC light engines. Moreover, the failure rate will also increase.

The tables below show the lifetime of PrevaLED® Cube AC DALI light engines according to IEC/PAS 62717.

PL-CUBE-AC-1100-8x0-230V-G3-DALI

	L70B10	L70B50	L80B10	L80B50	L0C10	L0C50	L70F10	L70F50	L80F10	L80F50
Lifetime [h] at t_c point = 65 °C	41000	50000	26000	36000	104000	104000	39000	50000	26000	35000
Lifetime [h] at t_c point = 70 °C	38000	50000	24000	33000	73000	73000	36000	50000	23000	32000
Lifetime [h] at t_c point = 75 °C	35000	48000	23000	31000	52000	52000	33000	47000	22000	30000
Lifetime [h] at t_c point = 80 °C	33000	45000	21000	28000	36000	36000	30000	44000	20000	27000
Lifetime [h] at t_c point = 90 °C	31000	43000	20000	27000	18000	18000	28000	41000	18000	26000

PL-CUBE-AC-2000-8x0-230V-G3-DALI

	L70B10	L70B50	L80B10	L80B50	L0C10	L0C50	L70F10	L70F50	L80F10	L80F50
Lifetime [h] at t_c point = 65 °C	50000	50000	35000	50000	82000	82000	48000	50000	33000	50000
Lifetime [h] at t_c point = 70 °C	47000	50000	31000	44000	58000	58000	41000	50000	29000	44000
Lifetime [h] at t_c point = 75 °C	41000	50000	27000	39000	41000	41000	36000	50000	25000	38000
Lifetime [h] at t_c point = 80 °C	36000	50000	24000	34000	29000	29000	31000	50000	22000	33000
Lifetime [h] at t_c point = 90 °C	28000	41000	18000	26000	14000	14000	23000	40000	16000	26000

PL-CUBE-AC-3000-8x0-230V-G3-DALI

	L70B10	L70B50	L80B10	L80B50	L0C10	L0C50	L70F10	L70F50	L80F10	L80F50
Lifetime [h] at t_c point = 65 °C	42000	50000	28000	41000	82000	82000	38000	50000	26000	40000
Lifetime [h] at t_c point = 70 °C	37000	50000	24000	36000	58000	58000	33000	50000	23000	35000
Lifetime [h] at t_c point = 75 °C	33000	49000	21000	31000	41000	41000	28000	47000	20000	31000
Lifetime [h] at t_c point = 80 °C	29000	43000	19000	28000	29000	29000	24000	42000	17000	27000
Lifetime [h] at t_c point = 90 °C	23000	34000	15000	22000	14000	14000	18000	33000	13000	21000

8 Mechanical considerations

8.1 Outline drawing

The following schematic drawing provides further details on the dimensions of PrevaLED® Cube AC DALI light engines. For 3D files of the light engines, please go to: www.inventronics-light.com.

Outline drawing

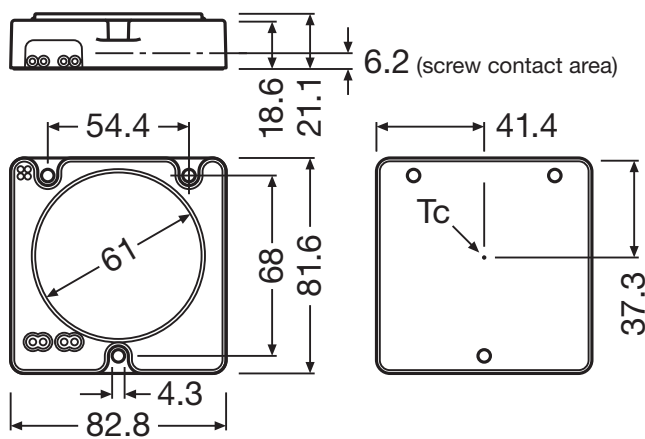

All figures in mm

8.2 3D drawing

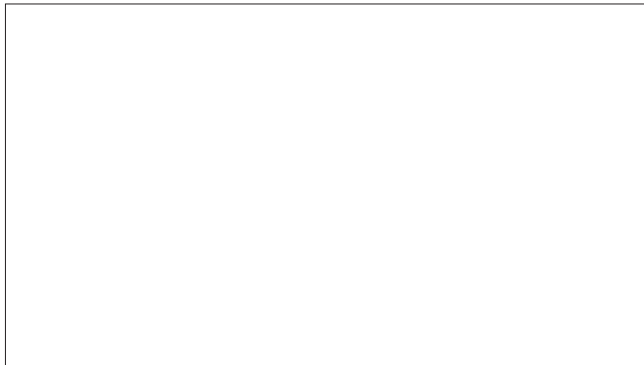

Move me!

Movable 3D PrevaLED® Cube AC DALI light engine (works with Adobe Acrobat 7 or higher)

8.3 Mechanical protection of the light engine

The housing of a PrevaLED® Cube AC DALI light engine should not be exposed to strong mechanical stress. Please apply force only to the dedicated mounting positions. Strong mechanical stress can lead to irreversible damage of the light engine.

Note: If the diffuser material at the light-emitting surface or any other part of the housing or the PCB is broken or mechanically damaged, you must no longer operate the light engine. Please replace it immediately to avoid contact with parts of the light engine that conduct 230V.

For operation in damp, wet or dusty environments, the user has to make sure that an adequate ingress protection is chosen. The light engine has to be protected by a suitable IP code of the luminaire housing. Please consider the luminaire standard IEC 60598-1 as well as the different requirements for indoor and outdoor application.

Note for France: Due to specific national regulations as defined in the standard EN 60598, it is not permitted to expose the light engine outside a luminaire housing.

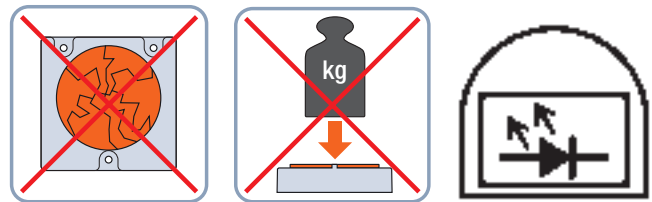

Don'ts

8.4. Mounting

To fix a PrevaLED® Cube AC DALI light engine to a heat sink, use M4 cylinder head screws according to DIN 912 or ISO 4762.

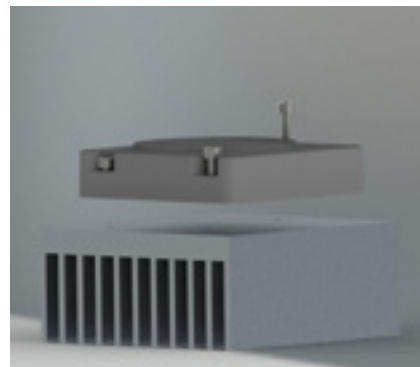

Mount the light engine from the top

Note:

Good experiences were made with a torque of $1.0 \pm 0.5 \text{ Nm}$, higher torque levels do not necessarily lead to significantly better heat transfer but may lead to damage of the light engine.

8.5 Protection from corrosion

To protect electronic parts (such as LEDs) from corrosion, a corrosive atmosphere around the components has to be avoided. In case of LEDs, H_2S , for example, is a highly corrosive substance which can lead to a drastically shortened product lifetime. The source for H_2S are sulfur-cross-linked polymers, such as rubber. To ensure the absence of H_2S , it is recommended to use peroxide-cross-linked materials, which are available on the market as an alternative to sulfur-cross-linked versions. Avoidance of corrosion by moisture has to be ensured by the appropriate protection of the luminaire housing (see chapter 3 "Ingress protection").

9 Norms and standards

Safety:	IEC/EN 62031 IEC/EN 60598-1 IEC 61347-1
Photobiological safety:	IEC/EN 62471 Risk group 1
Electromagnetic compatibility:	CISPR 15 IEC/EN 61547 IEC/EN 61000-3-2 IEC/EN 61000-3-3 EN 55015
Ingress protection:	IP20
Approval:	CE, ENEC, VDE, CB VDE
DALI 2:	IEC 62386-101:2014 IEC 62386-102:2014

Disclaimer

All information contained in this document has been collected, analyzed and verified with great care by INVENTRONICS. However, INVENTRONICS is not responsible for the correctness and completeness of the information contained in this document and INVENTRONICS cannot be made liable for any damage that occurs in connection with the use of and/or reliance on the content of this document. The information contained in this document reflects the current state of knowledge on the date of issue.

Use our contact form

www.inventronics-light.com/contact-us



Service contact:

Inventronics GmbH

Parkring 31-33, 85748 Garching, Germany

www.inventronics-light.com

support@inventronicsglobal.com

INVENTRONICS is a licensee of ams
OSRAM. OSRAM is a trademark of ams
OSRAM.

inventronics