

Light is plug & play

Easy installation of flexible complete systems

Choose OSRAM for components made to work together

Light is OSRAM

OSRAM

Versatile system components: OPTOTRONIC® LED drivers with constant voltage

The application of LED drivers with constant voltage offers great benefits for luminaire manufacturers and installers. Compared with constant current drivers, their installation is much easier. Despite this ease of installation, they can provide extremely precise dimming. Overall, less components are required, reducing complexity and therefore costs. The new driver ranges with the compact dimensions are also suitable for use in slim, flat luminaires or installations with limited space. Combined with LED modules, corresponding accessories and intelligent lighting control, the drivers offer high performance, efficiency and variability.



Our know-how
for your project –
contact us:
flex@osram.com

**For special applications with various requirements:
4 channels, numerous lighting solutions**

White, Tunable White, RGB and RGBW – thanks to their four output channels, the OPTOTRONIC® 4-channel LED drivers with 24 V constant voltage from OSRAM offer new application possibilities. The OPTOTRONIC® TW driver family is particularly well-suited for Tunable White solutions.



Highly sophisticated installations thanks to flat LED drivers and modules

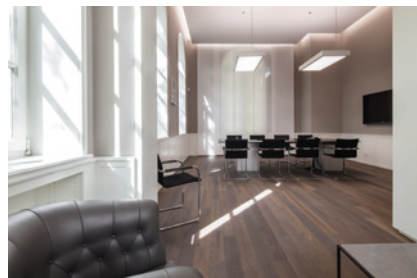

Daylight-dependent adjustment of light color and brightness, e.g. in offices or conference rooms



White lighting effects for various room situations, e.g. in hotels, shops, bars or restaurants



Emotionally stimulating scenarios for work, relaxation or entertainment

Complete systems for easy installation and top performance

With OSRAM, you can realize sophisticated lighting solutions with relatively little installation effort. We support you in compiling the right components by leading you step by step to a customized high-performance overall system. For this, we provide you with practical online tools and clearly arranged check lists. And if you still have unanswered questions, the experts of our technical support team will be happy to assist you. This performance package offers you a time-saving and cost-efficient way to a future-proof lighting system, which can be updated and extended at any time.

Overall solutions from OSRAM: powerful, versatile, future-proof

OPTOTRONIC® Constant voltage LED drivers



Innovative DALI LED drivers for quick and easy installation:

- Flexibility thanks to 4 channels (White, Tunable White, RGB and RGBW)
- Tunable White drivers (compatible with DALI Device Type 8), based on DALI temperature control
- Slim design for space-saving installations, e.g. in covers or flat luminaires
- Dimmable down to 0%/0.1% via DALI and TouchDIM
- Highly durable and extremely reliable
- EL-compliant

Flexessories®

Matching accessories for flexible LED modules:

- Easy mounting in any aluminum profile
- Tool-free and quick installation with mounting brackets and springs
- Diffusers and lenses
- No visible light gap thanks to lateral end caps

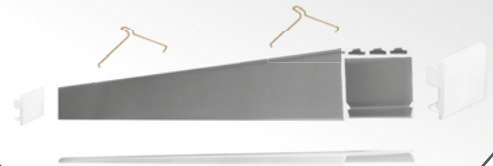

Practice-based services

Professional support at every stage of a project:

- Check lists for the perfect product combination
- Online tools for system optimization
- Technical support by our experts



* Detailed guarantee terms and conditions can be found at www.osram.com/guarantee

LINEARlight Flex® LED modules



LED modules for versatile use in white and colored applications:

- Easy mounting with Flexessories® without tools
- Low height for sophisticated lighting solutions
- Homogeneous light for excellent ambience

High-performance system

Guarantee

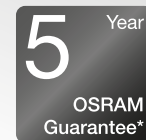

Comprehensive guarantee on all LED modules and drivers as well as LMS components

DALI MCU TW Lighting control



Intelligent light management system for convenient lighting control:

- Intuitive setting of brightness and color temperature
- Integrated DALI mains adapter
- Up to 4 control units with automatic synchronization
- Compatible with covers of common switch manufacturers

Strong products, even stronger when combined

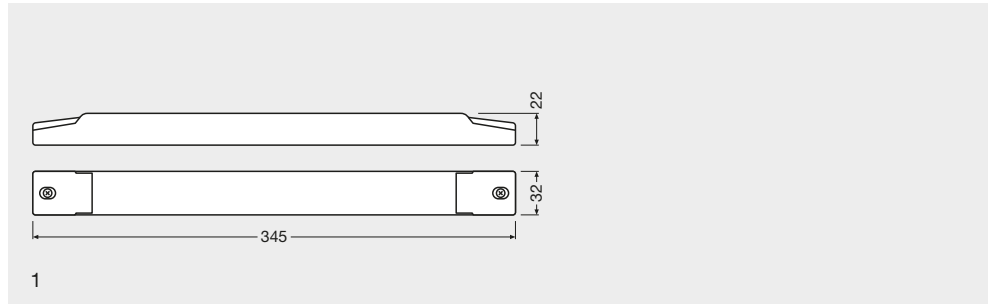

OPTOTRONIC® Tunable White and 4-channel DALI LED drivers

Product reference	GTIN (EAN)	Hz	V _{IN}	V _{OUT}	W	T _a			protection class	IP		No.
OTi DALI 50/220-240/24 TW	4052899490772	0/50/60	220-240	24 ¹⁾	50	-20...+45	Yes	0.1...100%	I / II	IP20		1
OTi DALI 80/220-240/24 TW	4052899490758	0/50/60	220-240	24 ¹⁾	80	-20...+45	Yes	0.1...100%	I / II	IP20		1
OTi DALI 50/220-240/24 1-4 CH	4052899452916	0/50/60	220-240	24 ¹⁾	50	-20...+45	Yes	0...100%	I / II	IP20		1
OTi DALI 80/220-240/24 1-4 CH	4052899452893	0/50/60	220-240	24 ¹⁾	80	-20...+45	Yes	0...100%	I / II	IP20		1

1) DC voltage

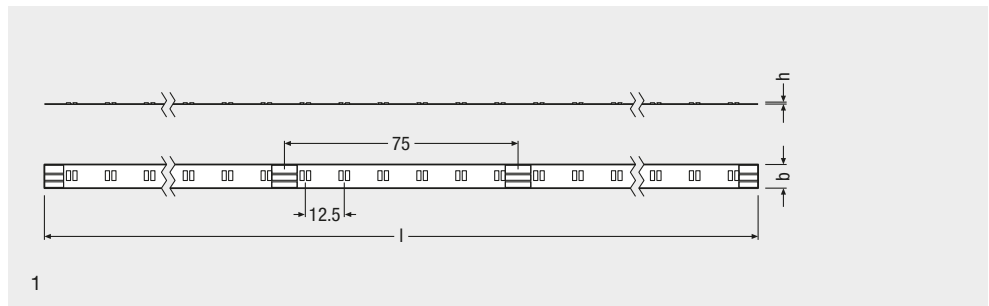

LINEARlight Flex® Power Tunable White and Colormix

Product reference	GTIN (EAN)	COLOR	K, λ	V	W _{METER}	$\frac{l}{[mm]}$	$\frac{b}{[mm]}$	$\frac{h}{[mm]}$	lm _{METER}	lm/W		No.
LF4000TW-G3-82765-02	4052899953260	Dynamic	2700-6500K	24	36.8	2100	8	1.45	3800	103		1
LF3000TW-G3-82765-03	4052899953277	Dynamic	2700-6500K	24	30	3000	8	1.45	3000	100		1
LF2000TW-G3-82765-04	4052899953284	Dynamic	2700-6500K	24	18.5	4500	8	1.45	2000	108		1
LF1200TW-G3-82765-09	4052899953161	Dynamic	2700-6500K	24	10.5	9000	8	1.45	1200	114		1
LF05CA2-RGB3	4008321851536	RGB	625/525/467	24	18.0	4000	8	2.2	470	26		-
LF05CE-RGB1	4008321593375	RGB	625/525/467	24	6.5	6000	8	2.2	180	28		33
LF05CA-RGB3-P	4008321977205	RGB	625/525/467	24	18.0	4000	11	4.5	435	-		50
LF05CE-RGB1-P	4008321977182	RGB	625/525/467	24	6.5	6000	11	4.5	180	-		33

Additional white and colored LINEARlight Flex® can be found at www.osram.com/flex.

Backlighting LED modules can be found at www.osram.com/backlighting.

For Flexessories® – dedicated accessories for Flex LED modules – please visit www.osram.com/flexessories.

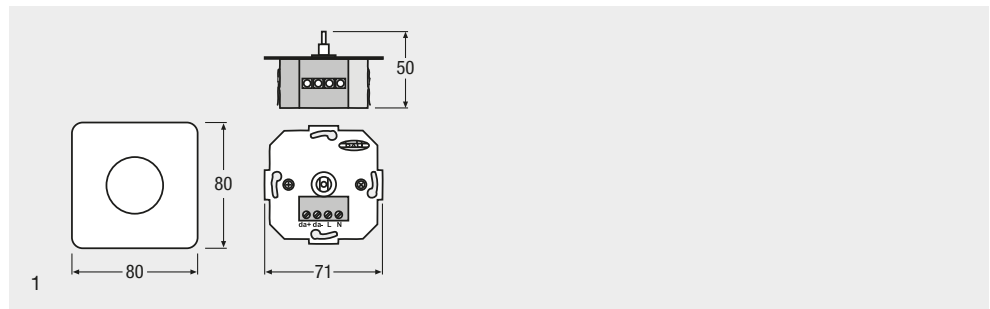

DALI MCU Tunable White

Product reference	GTIN (EAN)	V	CONTROL	No. of OUTPUTS	Yes	IP	Can be integrated into flush box	T _a	COLOR	No.
DALI MCU TW	4052899465916	230	DALI	1	Yes	IP20	Can be integrated into flush box	0...+50	White	1

Comprehensive and individual support for your project

On the way to the ideal product combination, we support your project from the planning to the implementation stage. This gives you the security of a highly functional and reliable total package.

Technical support

Practice-based consultation and the technical know-how of our experts provide the basis for sustainable lighting concepts that meet your specific requirements.

Professional online tools

With the Flex Configurator, you can plan your individual lighting solution with Flex LED modules step by step (www.osram.com/flex). The LED deSIGNer allows you to calculate the exact number of components (LED modules, drivers and mounting profiles) for side lighting and back-lighting projects (www.osram.com/led-designer).

Guarantee

Based on the high quality and durability of our products, we give you a guarantee of 5 years on all LED modules, LED drivers and LMS components that are used in the professional lighting market. No registration is required for this.*

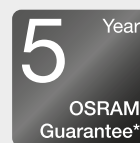

























Check lists

At www.osram.com/led-designer, you can find check lists, e.g. for light ceiling and wall applications, which allow you to specify the required details about your project. Based on these details, we can give you individual advice and compile perfectly matched products for you.



* Detailed guarantee terms and conditions can be found at www.osram.com/guarantee

Symbols

 COLOR	Color	 $\frac{l}{[mm]}$	Length l in mm
 K	Color temperature in K	 $\frac{h}{[mm]}$	Height h in mm
 V	Voltage in V	 $\frac{b}{[mm]}$	Width b in mm
 V_{IN}	Input voltage in V	 CONTROL	Control
 V_{OUT}	Output voltage in V	 No. of OUTPUTS	Number of control outputs
 W	Power in W		Dimmable
 λ	Power factor/wavelength	 IP	Type of protection
 $\frac{W}{METER}$	Nominal wattage per meter in W	 pro-tection class	Protection class
 $\frac{lm}{METER}$	Luminous flux per meter	 T_a	Ambient temperature range in °C
 $\frac{lm}{W}$	Luminous efficacy		Type of installation
 Hz	Operating frequency in Hz	 W	Dimming range
 $\frac{LED}{METER}$	Number of LEDs per meter	 No.	Fig. no.

OSRAM GmbH

Head office:

Marcel-Breuer-Strasse 6
80807 Munich, Germany
Phone +49 89 6213-0
Fax +49 89 6213-2020
www.osram.com

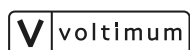

OSRAM