

# Light is controllable

## DALI PCU – control unit for standard pushbuttons

For easy, convenient and cost-efficient dimming

Light is OSRAM

**OSRAM**

# Light management made easy

Simple dimming with the DALI PCU control unit for standard pushbuttons.

Efficient light management doesn't have to be complex and time-consuming. The DALI PCU is a compact control unit with integrated DALI current supply for manual dimming and switching of DALI luminaires via all standard pushbuttons. This all-in-one device allows for the easy and cost-efficient implementation of small and medium-sized projects.

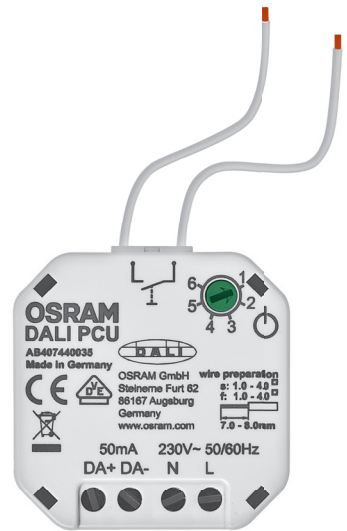

## Wide variety of applications

Light control in the following areas:

- Conference and training rooms
- Offices
- Retail
- Hospitality
- Residential

## The installation of the DALI PCU is as easy as it gets:



**01** Connect the DALI PCU to the mains and DALI wires.



**02** Place the DALI PCU into the flush box.

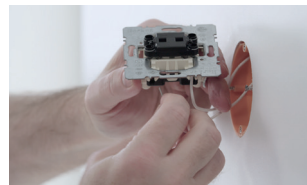

**03** Connect the DALI PCU to the pushbutton.



**04** Mount the cover of the pushbutton.

## Easy installation in standard flush boxes

The installation of the DALI PCU is very easy. Only one component is required for the entire light control. After the connection to the mains and DALI wires, the DALI PCU is placed into the flush box and connected to the pushbutton – ready. This way, you turn a standard pushbutton into a fully functional DALI control unit. This plug-and-play solution offers many functions for convenient light management.

- Dimming and switching of any type of DALI luminaires
- Automatic or manual storage of the switch-on level
- Individual setting of the lowest dimming level
- Individual configuration of the behavior after mains interruption
- Up to four control points can be realized
- DALI voltage supply already integrated
- Combinable with standard motion or presence detectors
- Suitable for separable rooms with separation walls



# One device for different room types and room sizes

Flexible light control in standard and special applications.

In many fields of application, the DALI PCU demonstrates a high level of flexibility and ease of use. A DALI PCU controls up to 25 luminaires, up to 4 units can be connected in parallel and will synchronize automatically. This allows for the realization of projects with up to 4 control

points and up to 100 luminaires, for example in offices or conference rooms. Rooms with separation walls can also be switched and dimmed flexibly with simple means. Further savings are possible in combination with standard motion or presence detectors.

## Standard applications

### 2 control points and 25 luminaires

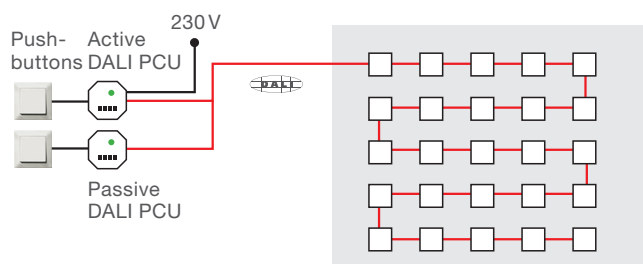

- Up to 25 luminaires with one active DALI PCU
- Second control point (passive DALI PCU) is supplied directly via the DALI line

### 4 control points and 100 luminaires

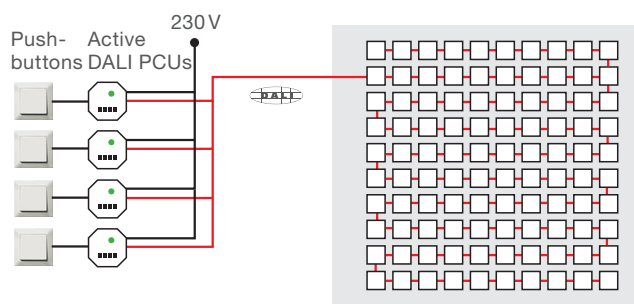

- Up to 100 luminaires with four active DALI PCUs
- DALI cable length of up to 300 meters

## Special applications

### Rooms with separation walls (e.g. separated conference rooms)

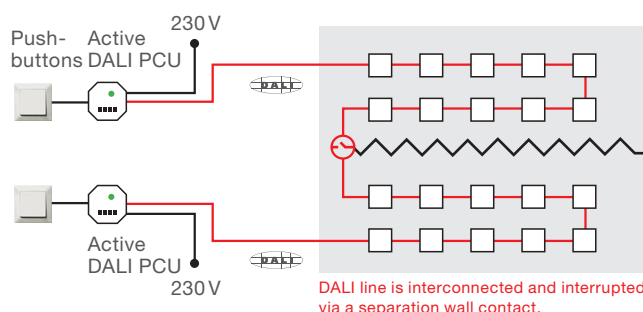

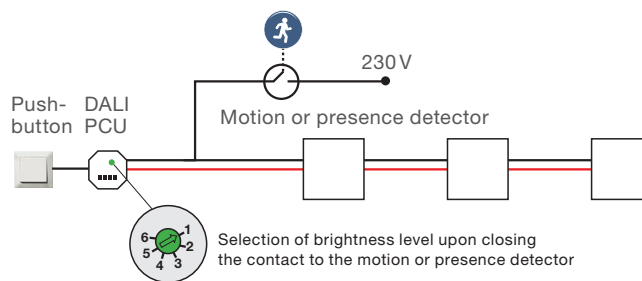

- Up to four separated rooms can be realized
- Local control of the individual separated rooms by local control unit (wall closed) or central control by all DALI PCUs (wall open)
- No commissioning required
- One-wire interruption of the DALI line is sufficient when the wall is closed

### Combination with standard motion or presence detectors

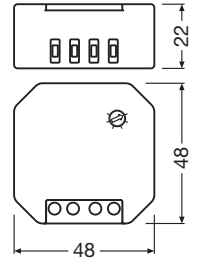

- Further energy savings through presence detection
- Automatic switch-on/switch-off by the motion or presence detector
- Manual dimming and switching possible as soon as presence is detected
- Switch-off of standby power consumption by the motion or presence detector



Product name	GTIN (EAN)	V	Hz	W SYSTEM	IP	CONTROL	No. of OUTPUTS	T <sub>a</sub>	
DALI PCU	4052899955622	230	50/60	2	IP20	DALI	1	0...+40 °C	For installation in flush boxes

OSRAM GmbH

Head office:

Marcel-Breuer-Strasse 6  
 80807 Munich, Germany  
 Phone +49 89 6213-0  
 Fax +49 89 6213-2020  
 www.osram.com

Partner:



**OSRAM**