

04/2023

Technical application guide
PrevaLED® Flat AC G3
light engine family

OSRAM

Contents

1 Introduction	03	8 PL-FLAT-AC emergency lighting	20
1.1 System overview	03	8.1 Local emergency (L-EM)	20
1.2 Ordering information	04	8.2 Central emergency (C-EM)	21
1.3 Nomenclature	05	8.2.1 General	21
		8.2.2 PrevaLED® Flat AC G3 Master/DALI versions	21
2 Optical considerations	06	8.2.3 PrevaLED® Flat AC G3 Slave versions	21
2.1 Light distribution	06	8.2.4 PrevaLED® Flat AC G3 emergency versions	21
2.2 Light modulation	06		
2.3 Homogeneity	07	9 PL-FLAT-AC MA functionality	22
2.4 Color temperature	08	9.1 General information	22
2.5 Color rendering	09	9.2 User interface	22
2.6 Spectral distribution	09	9.3 Commissioning	22
		9.4 Motion detection sensibility, detection area	22
3 Ingress protection	10	9.5 Hold time	23
		9.6 Ambient light level threshold	23
4 Electrical considerations	10	9.6.1 Adjustment of the threshold in steps	23
4.1 Wiring information	10	9.6.2 Adjustment of the threshold by “teach mode”	23
4.2 Insulation requirements	11	9.7 Corridor Function	23
4.3 Inrush current and system installation	11	9.8 Factory reset	23
4.4 Electrostatic discharge (ESD)	11		
4.5 Phase-cut dimming	11	10 PL-FLAT-AC Master/Slave system	24
4.6 Power as a function of voltage	11	10.1 PrevaLED® Flat AC G3 Master/Slave system	24
		10.2 Wiring set-up	24
5 Thermal considerations	12	10.3 Connectable load	24
5.1 Thermal power values	12	10.4 Operation mode	24
5.2 Thermal power as a function of voltage	12	10.4.1 Operation of a PrevaLED® Flat AC G3	
5.3 Thermal derating	12	Master/Slave system comprising one Master	24
5.4 TIM and other accessories	12	10.4.2 Operation of a PrevaLED® Flat AC G3	
5.5 tc point location and temperature measurement	13	Master/Slave system comprising two or more Masters	25
		10.5 Multiple light engines in one luminaire – luminaire mode	25
6 Lifetime and thermal behavior	14	10.6 Identification of Master and sub-Master/s	
6.1 Cooling	14	in existing installations	25
6.2 Luminous flux as a function of temperature	14		
6.3 Lifetime as a function of temperature	14	11 PL-FLAT-AC DALI	26
		11.1 Introduction	26
7 Mechanical considerations	18	11.2 Additional functions integrated in PL-FLAT-AC-DA	26
7.1 Outline drawings	18	11.2.1 Touch DIM®	26
7.2 Mechanical protection of the light engine	19	11.2.2 Corridor Function	27
7.3 Touch protect accessory	19	11.2.3 SMART GRID function	27
7.4 Protection from corrosion	19	11.3 Digital programming and parametrization options	27
7.5 Mounting	19	11.3.1 General	27
		11.3.2 Parametrization by Tuner4TRONIC® software	28
		12 Norms and standards	30

Please note:

All information in this guide has been prepared with great care. INVENTRONICS, however, does not accept liability for possible errors, changes and/or omissions. Please check www.inventronics-light.com or contact your sales partner for an updated copy of this guide. This technical application guide is for information purposes only and aims to support you in tackling the challenges and taking full advantage of all opportunities the technology has to offer. Please note that this guide is based on own measurements, tests, specific parameters and assumptions. Individual applications may not be covered and need different handling. Responsibility and testing obligations remain with the luminaire manufacturer/OEM/application planner.

1 Introduction

1.1 System overview

Efficient and smart lighting devices that also look good are increasing the global demand for LED lighting and controls. Building an LED-based luminaire poses a new set of technical challenges, among them new optical requirements, providing adequate thermal management for stable operation and dealing with the ever-improving performance of LEDs. Nevertheless, LED technology also offers an unknown wealth of possibilities, providing access to unprecedented levels of performance and new ways of integration.

Our PrevaLED® family of LED light engines addresses the challenges of LED-based lighting while providing users with great performance and flexibility at the same time. Enabled by the application of LED technology, PrevaLED® is aiming to push the envelope of what is possible in terms of performance and simplicity.

The PrevaLED® Flat AC G3 family of light engines is ideally suited for use in highly diffuse wall-mounted and ceiling-mounted luminaires in decorative, hospitality or domestic applications.

With our PrevaLED® Flat AC G3 Master/Slave system, for example, we provide an all-in-one solution to create flat and homogeneous diffuser luminaires. Saving energy can be achieved by using sensor technology instead of switched applications. And, as these sensors are inside the luminaire, an attractive application design is possible.

From a money-saving perspective, the PrevaLED® Flat AC G3 Master/Slave system also gives our customers advantages as one Master device can be combined with up to ten Slave devices, which are much less expensive. Thus, a total set-up of eleven luminaires per system is possible.

The integrated sensors of the PrevaLED® Flat AC MA G3 can be configured regarding detection area, hold time of lighting and ambient light sensitivity. This guarantees maximum flexibility and individual applications according to the prevailing market trend of miniaturization and complexity reduction.

PrevaLED® Flat AC G3 light engines provide several specific benefits to help our customers to meet the market demand for smaller luminaires without compromising light quality:

- A separate LED circuit, not used during normal operation, can be run on a local battery pack to enable the local emergency lighting functionality.
- Only a little design-in effort is necessary because the electronic control circuitry is already integrated in the light engine (integrated system solutions).
- They provide high performance in terms of both the complete system efficiency and the quality of light, enabling the design of ultra-slim diffuser luminaires.
- They allow simple and flexible LED technology applications in existing and new installations.
- A touch protect accessory can be purchased along with the light engine to allow for safe operation in luminaires that can be opened by the end user.

The PrevaLED® Flat AC G3 series is available in five different versions:

- **PC version PL-FLAT-AC-PC**
Includes driver on board
- **Emergency version PL-FLAT-AC-EM**
Includes C-EM (central battery) and L-EM (local battery) function
- **Master version PL-FLAT-AC-MA**
Includes HF sensor and ambient light sensor, C-EM and L-EM function and MA/SL control
- **Slave version PL-FLAT-AC-SL**
To be connected to the Master version
- **DALI version PL-FLAT-AC-DA**
Fully dimmable and DALI compatible, includes C-EM and L-EM function

Each version is available with a diameter of 170 mm (1500lm) or 240 mm (2500lm) and a color temperature of 3000K or 4000K. All PrevaLED® Flat AC G3 light engines have a minimum color rendering index of CRI > 80.

Please note:

For some versions, two additional diameters are available (335 and 415 mm). Please check the product reference on the next page.

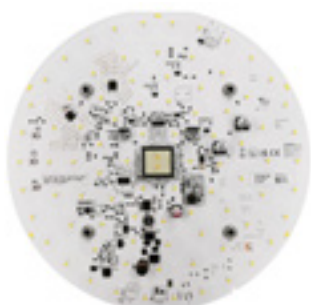

PrevaLED® Flat AC MA G3 (2500lm)

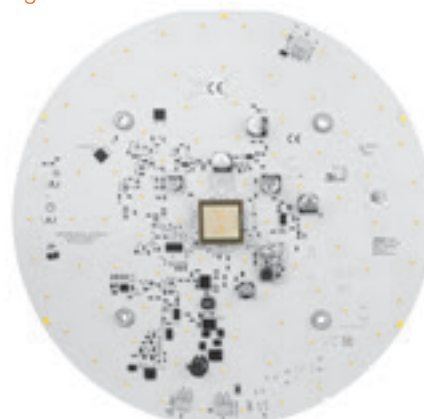

PrevaLED® Flat AC MA G3 (240mm; 2500lm)

1.2 Ordering information

PrevaLED® Flat AC G3 family

Product reference	Product number [EAN-010]	Product number [EAN-040]	Color temperature [K]	Luminous flux [lm]
PC version				
PL-FLAT-AC-PC-G3 1500-830 230V	4062172209427	4062172209434	3000	1500
PL-FLAT-AC-PC-G3 1500-840 230V	4062172209441	4062172209458	4000	1500
PL-FLTP 170 G2/G3 (touch protect accessory)	4052899969872	4052899970151		
PL-FLAT-AC-PC-G3 2500-830 230V	4062172203425	4062172203432	3000	2500
PL-FLAT-AC-PC-G3 2500-840 230V	4062172203449	4062172203456	4000	2500
PL-FLTP 240 G2/G3 (touch protect accessory)	4052899969889	4052899970168		
PL-FLAT-AC-PC-G3 3300-830 230V	4062172212175	4062172212182	3000	3300
PL-FLAT-AC-PC-G3 3300-840 230V	4062172212335	4062172212342	4000	3300
PL-FLTP 335 G2/G3 (touch protect accessory)	4052899530102	4052899530119		
PL-FLAT-AC-PC-G3 4000-830-230V	4062172212397	4062172212403	3000	4000
PL-FLAT-AC-PC-G3 4000-840-230V	4062172212410	4062172212427	4000	4000
PL-FLTP 415 G2/G3 (touch protect accessory)	4052899968479	4052899968486		
Emergency version				
PL-FLAT-AC-EM-G3 1500-830 230V	4062172209465	4062172209472	3000	1500
PL-FLAT-AC-EM-G3 1500-840 230V	4062172209489	4062172209496	4000	1500
PL-FLTP 170 G2/G3 (touch protect accessory)	4052899969872	4052899970151		
PL-FLAT-AC-EM-G3 2500-830 230V	4062172203463	4062172203470	3000	2500
PL-FLAT-AC-EM-G3 2500-840 230V	4062172203487	4062172203494	4000	2500
PL-FLTP 240 G2/G3 (touch protect accessory)	4052899969889	4052899970168		
PL-FLAT-AC-EM-G3 3300-830 230V	4062172212359	4062172212366	3000	3300
PL-FLAT-AC-EM-G3 3300-840 230V	4062172212373	4062172212380	4000	3300
PL-FLTP 335 G2/G3 (touch protect accessory)	4052899530102	4052899530119		
Master version				
PL-FLAT-AC-MA-G3 1500-830 230V	4062172209304	4062172209311	3000	1500
PL-FLAT-AC-MA-G3 1500-840 230V	4062172209328	4062172209335	4000	1500
PL-FLTP 170 MA G2/G3 (touch protect accessory)	4052899969858	4052899970137		
PL-FLAT-AC-MA-G3 2500-830 230V	4062172203302	4062172203319	3000	2500
PL-FLAT-AC-MA-G3 2500-840 230V	4062172203326	4062172203333	4000	2500
PL-FLTP 240 MA G2/G3 (touch protect accessory)	4052899969865	4052899970144		
Slave version				
PL-FLAT-AC-SL-G3 1500-830 230V	4062172209342	4062172209359	3000	1500
PL-FLAT-AC-SL-G3 1500-840 230V	4062172209366	4062172209373	4000	1500
PL-FLTP 170 G2/G3 (touch protect accessory)	4052899969872	4052899970151		
PL-FLAT-AC-SL-G3 2500-830 230V	4062172203340	4062172203357	3000	2500
PL-FLAT-AC-SL-G3 2500-840 230V	4062172203364	4062172203371	4000	2500
PL-FLTP 240 G2/G3 (touch protect accessory)	4052899969889	4052899970168		
DALI version				
PL-FLAT-AC-DA-G3 1500-830 230V	4062172209380	4062172209397	3000	1500
PL-FLAT-AC-DA-G3 1500-840 230V	4062172209403	4062172209410	4000	1500
PL-FLTP 170 G2/G3 (touch protect accessory)	4052899969872	4052899970151		
PL-FLAT-AC-DA-G3 2500-830 230V	4062172203388	4062172203395	3000	2500
PL-FLAT-AC-DA-G3 2500-840 230V	4062172203401	4062172203418	4000	2500
PL-FLTP 240 G2/G3 (touch protect accessory)	4052899969889	4052899970168		
PL-FLAT-AC-DA-G3 4000-830 230V	4052899605626	4052899605633	3000	4000
PL-FLAT-AC-DA-G3 4000-840 230V	4052899605640	4052899605657	4000	4000
PL-FLAT-AC-DA-G3 5000-830 230V	4052899605664	4052899605671	3000	5000
PL-FLAT-AC-DA-G3 5000-840 230V	4052899605688	4052899605695	4000	5000

1.3 Nomenclature

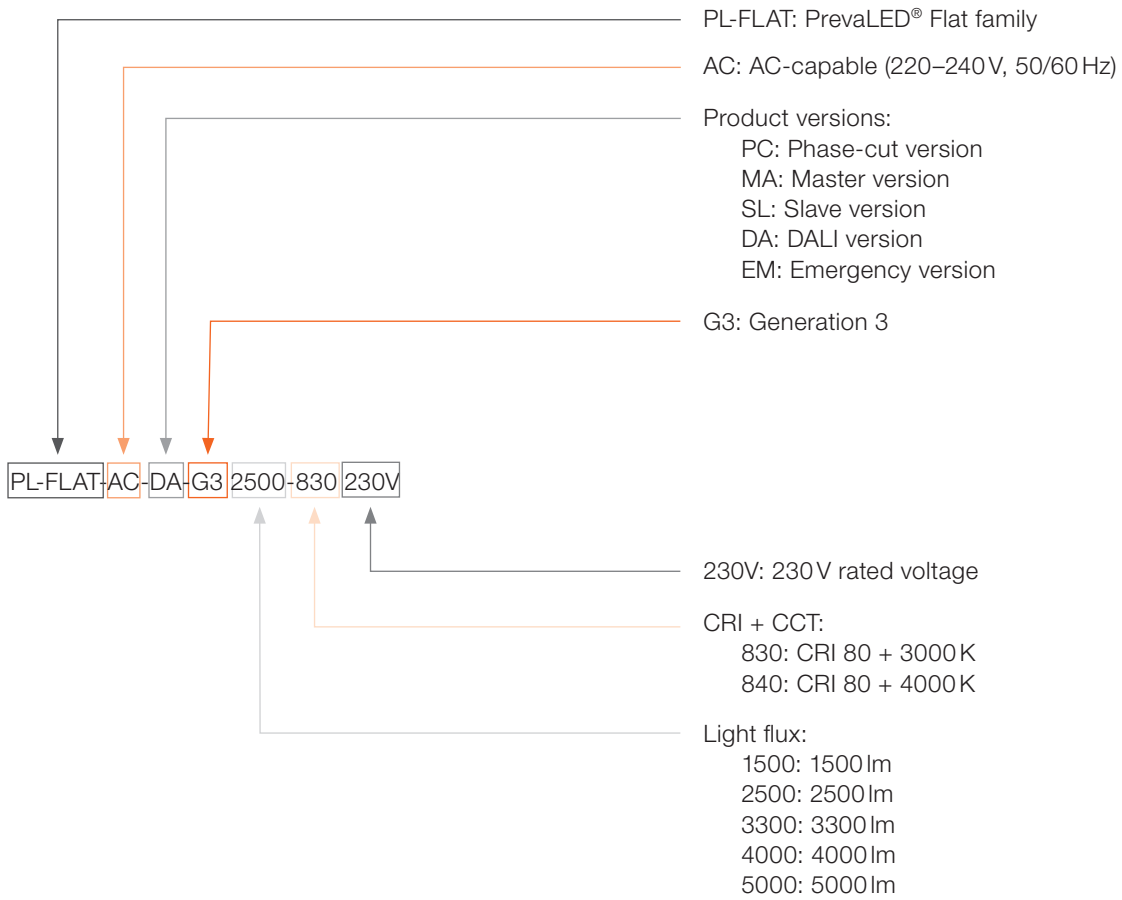

2 Optical considerations

PrevaLED® Flat AC G3 light engines can be applied in diffuse wall-mounted and ceiling-mounted luminaires without the need for further optical accessories.

2.1 Light distribution

The light distribution of PrevaLED® Flat AC G3 light engines is shown below. They create a beam angle of 110° FWHM (full width at half maximum) for all 1500lm versions or 140° FWHM for all 2500lm versions.

2.2 Light modulation

The AC technology of the PrevaLED® Flat AC G3 results in a light modulation with a frequency of 100Hz. Capacitors are placed into the PrevaLED® Flat AC G3 light engines to reduce the modulation of the light output. The resulting light modulation depth is lower than 15 %. The PrevaLED® Flat AC G3 product family complies with new ERP flicker requirements, with a short-term flicker severity index of $PSTLM \leq 1$ and a stroboscopic visibility measure (SVM) index of ≤ 0.9 .

Light distribution curve for 1500/2500/3300/4000 PC versions – 115°

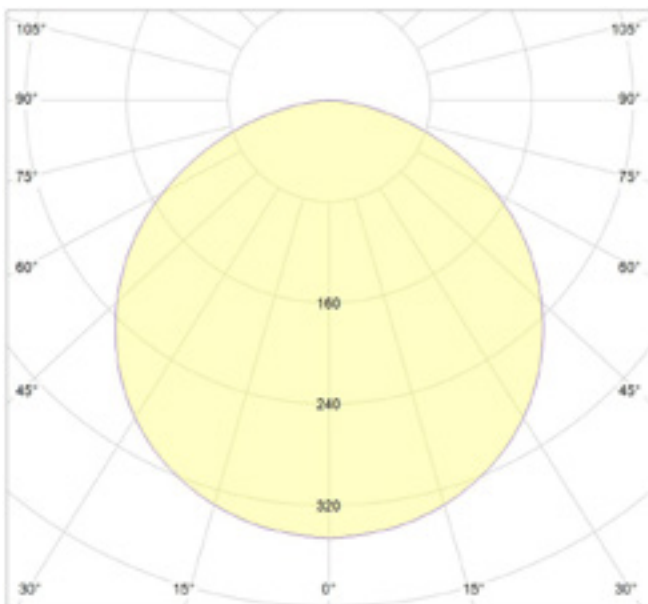

Light distribution curve for 4000 DA/5000 versions – 120°

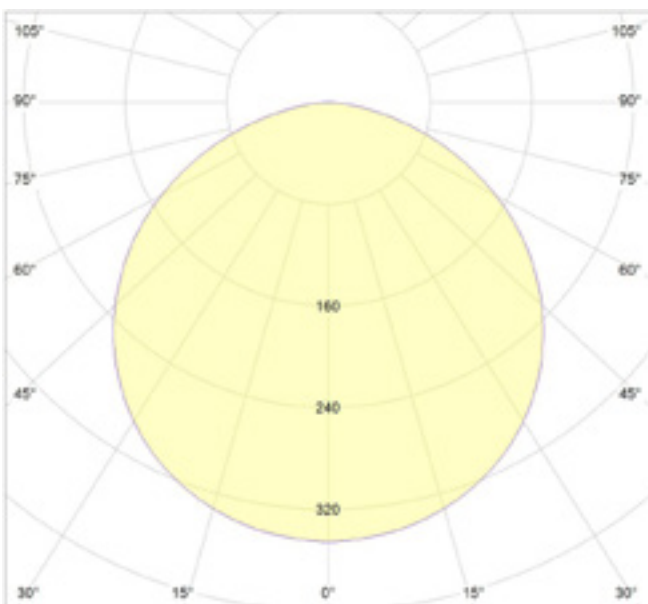

2.3 Homogeneity

To get the best homogeneity in slim luminaire designs, the illuminance and color appearance at different distances between the light engine and the diffuser should be tested. Simulations performed with a 170-mm-diameter PrevaLED® Flat AC G3 light engine (without touch protect accessory) and an exemplary diffuser showed that the ideal distance between the LEDs and the diffuser is 45 mm, as shown in the following images. This is transferable to all models of the PrevaLED® Flat AC G3 light engine family without sensor.

Exemplary visualizations for PrevaLED® Flat AC G3 light engines without sensor and without touch protect accessory

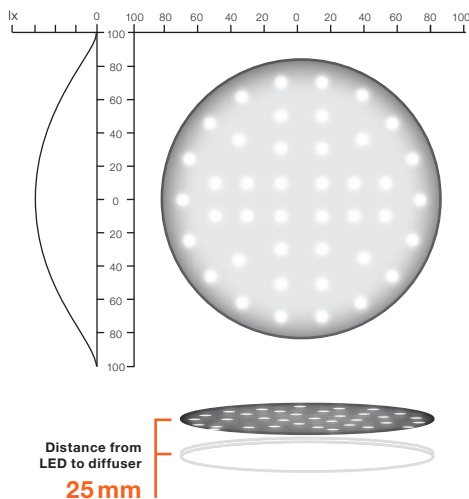
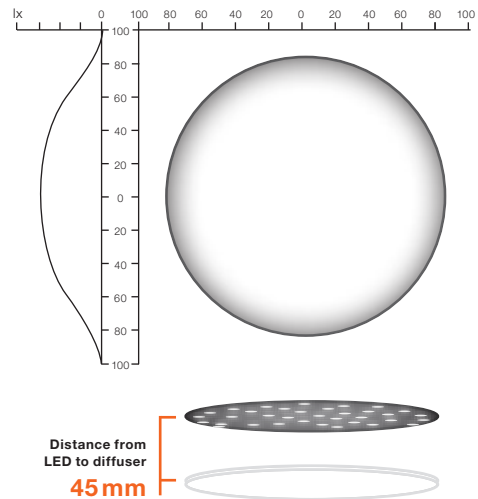
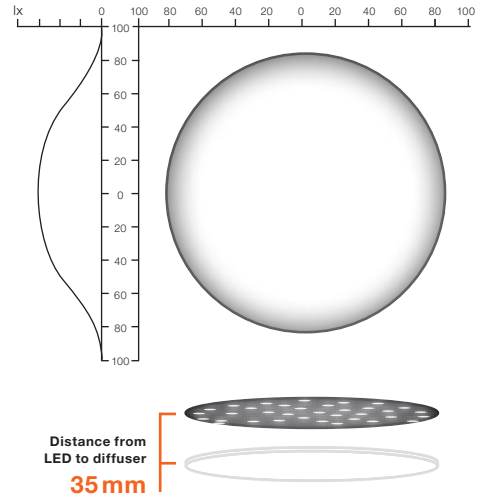
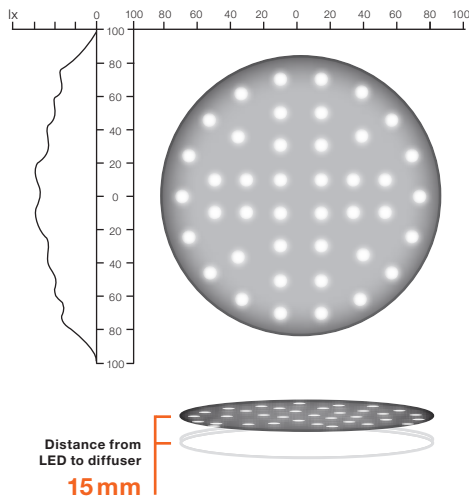

Simulation results show that the homogeneity values do not further improve when the distance between the PCB and the ideal diffuser layer exceeds 45 mm. For even better homogeneity when using the PrevaLED® Flat AC MA G3, the ideal distance to the diffuser layer usually should be between 45 mm and 55 mm but can differ due to the material characteristics of the diffuser from use case to use case.

We provide mechanical (3D files) and optical simulation data (IDT/IES files) to support customized diffuser designs. Mechanical files and optical data files can be downloaded from the product family data sheet available on each product version web landing page: www.inventronics-light.com.

Note: The best diffuser distance depends on the material characteristics of the diffuser and can differ from use case to use case!

2.4 Color temperature

The PrevaLED® Flat AC G3 series is currently available in 3000K and 4000K. The color coordinates within the CIE 1931 color space are given below.

Color coordinates for the different product versions

	3000K		4000K	
	C _x	C _y	C _x	C _y
1500lm	0.436	0.402	0.384	0.378
2500lm	0.430	0.398	0.379	0.374
3300lm	0.430	0.398	0.379	0.374
4000lm PC	0.430	0.398	0.379	0.374
4000lm DA	0.430	0.400	0.380	0.377
5000lm	0.430	0.400	0.380	0.377

Within each available color temperature, the PrevaLED® Flat AC G3 series provides a maximum color variation of three threshold value units (MacAdam steps). The following diagram shows these threshold values within the CIE 1931 color space.

Color coordinates: 1500lm versions

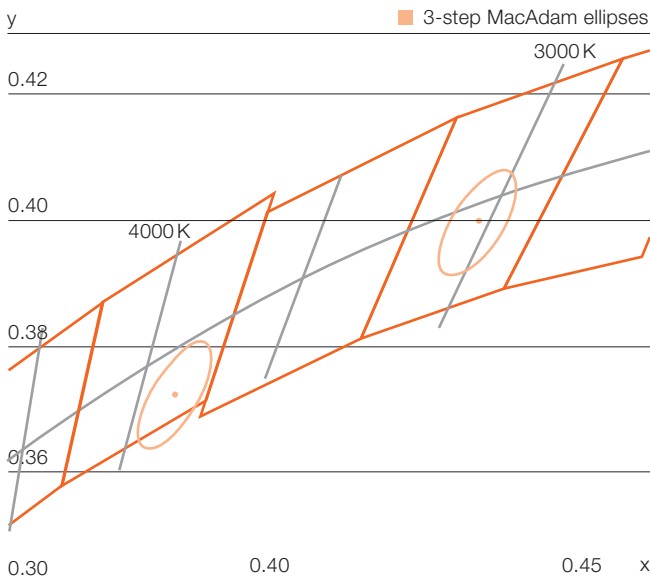

Color coordinates:

2500lm, 3300lm, 4000lm PC versions

y 3-step MacAdam ellipses

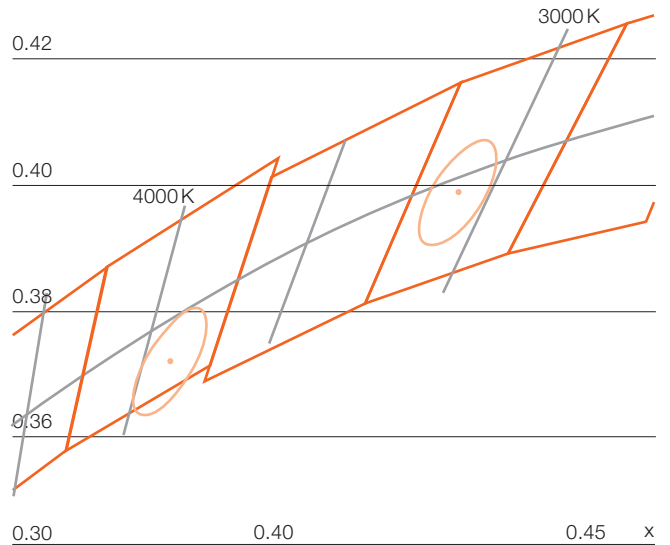

Color coordinates:

3300lm, 4000lm, 5000lm PC versions

y 3-step MacAdam ellipses

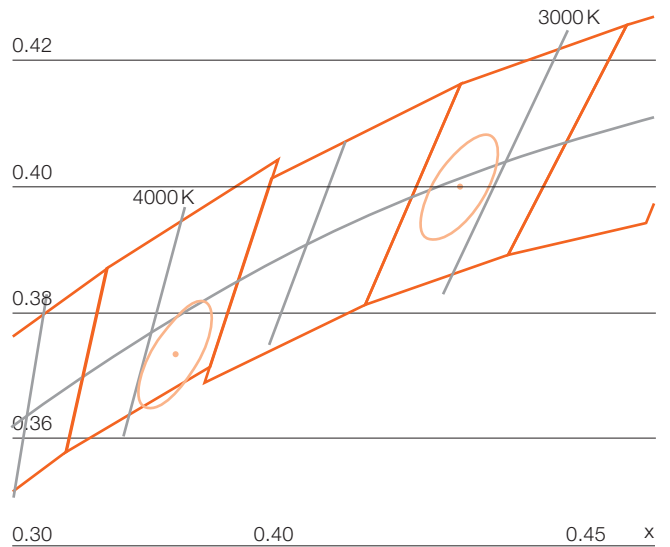

2.5 Color rendering

PrevaLED® Flat AC G3 light engines provide a color rendering index (CRI) of > 80. The table below shows the individual R_a values from R1 to R14 for the available color temperatures.

R_a values (average guiding values for reference only)

Model	CRI	General CRI	Dusky pink	Mustard yellow	Yellowish green	Light green	Turquoise	Azure	Aster violet	Lilac violet	Red, saturated	Yellow, saturated	Green, saturated	Blue, saturated	Pink, skin color	Leaf green
		R _a	R1	R2	R3	R4	R5	R6	R7	R8	R9	R10	R11	R12	R13	R14
1500lm (all versions) – 3000K	84	82	91	97	82	83	90	83	61	11	80	82	74	84	99	
1500lm (all versions) – 4000K	84	83	90	95	83	83	86	86	66	14	77	83	65	85	98	
2500/3300/PC 4000lm – 3000K	83	81	90	97	81	81	87	84	61	9	77	80	68	83	99	
2500/3300/PC 4000lm – 4000K	83	81	90	95	80	80	85	86	63	6	75	79	59	83	98	
DA 4000/5000lm – 3000K	83	82	93	94	80	82	91	82	59	9	84	79	72	85	98	
DA 4000/5000lm – 4000K	82	80	88	93	82	81	83	86	65	6	71	81	62	82	96	

2.6 Spectral distribution

The typical spectral distribution of PrevaLED® Flat AC G3 light engines is shown in the following diagram.

Wavelength spectrum (average guiding values for reference only)

1500lm, 2500lm, 3300lm, 4000lm PC version at t_c=25 °C

4000lm, 5000lm DA version at t_c=25 °C

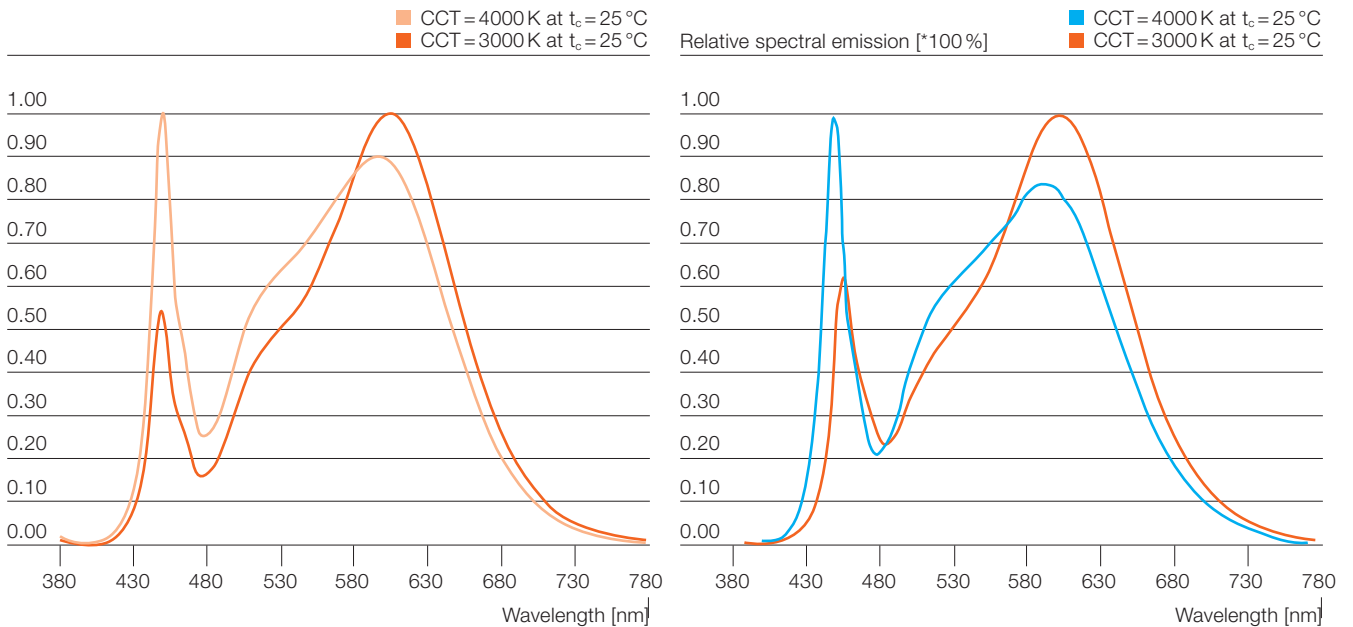

3 Ingress protection

PrevaLED® Flat AC G3 light engines have no ingress protection rating. Please ensure that the housing of a luminaire provides the IP protection required for the application. To achieve an ingress protection rating of IP20, it is possible to combine PrevaLED® Flat AC G3 light engines with the available touch protect accessories.

For further information, please have a look at the technical application guide “IP codes in accordance with IEC 60529”, which can be downloaded at www.inventronics-light.com

4 Electrical considerations

4.1 Wiring information

PrevaLED® Flat AC G3 light engines can be directly connected to mains voltage (220–240V, 50/60Hz). The used input connectors (WAGO 2060-402) can handle solid or flexible wire with a cross-section of 0.2 to 0.75 mm² (AWG 24–18). The use of solid wire is recommended. Only PrevaLED® Flat AC G3 Master or Slave devices shall be connected to the Master-out terminal. The EM (emergency) terminal must be connected only with a suitable local battery pack. The DALI terminal must be connected only with DALI bus drivers or Touch DIM®/Corridor Function sensors and switches.

Please see chapter 7.1 for the exact terminal positions on the light engine.

Wire preparation

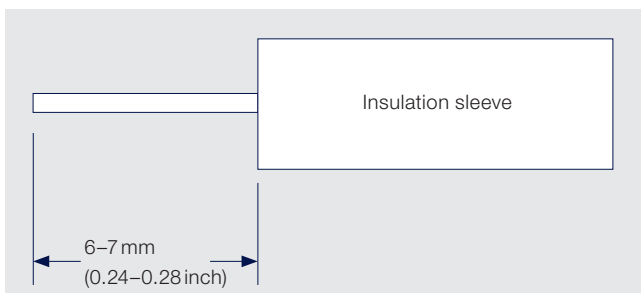

Please insert the wires in 0° orientation into the PCB.

Notes:

- The connector is designed for three poke-in and release cycles.
- Due to the fact that installation deals with mains voltage, hot-plugging of the light engine is not allowed.
- The installation of LED light engines needs to be carried out in compliance with all applicable electrical and safety standards. Only qualified personnel should be allowed to perform installations.

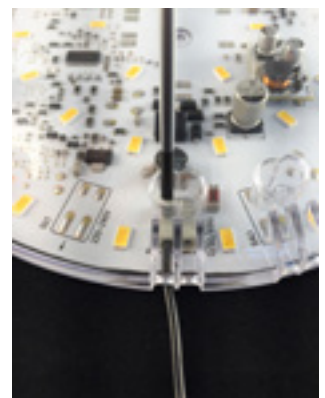
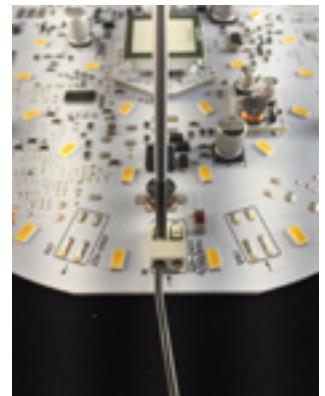
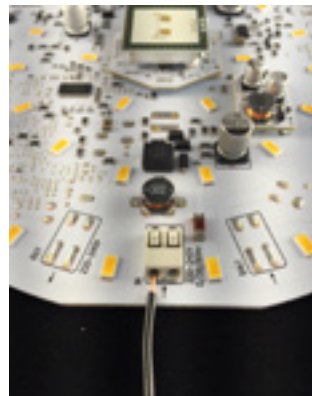

Solid wire:
Plug directly.

Flexible wire:
1. Slightly press the push button of the connector.
2. Insert the flexible wire.

To press/release the connector buttons, please use a small screwdriver or a WAGO operating tool for type 2060-402.

4.2 Insulation requirements

The PrevaLED® Flat AC G3 light engines have reinforced insulation towards the back of the PCB. The light engine provides no protection against electric shock.

When the light engines are used in protection class I luminaires, the luminaire manufacturer has to ensure basic insulation of the light engines and all live parts. It is also possible to use the optional touch protect accessory in order to provide the basic insulation of the light engines. Please refer to chapter 7.3 for additional information on the available touch protect accessories.

When the light engines are used in protection class II luminaires, the manufacturer has to ensure double or reinforced insulation of the light engines and all live parts. Moreover, it is necessary to provide additional insulation in the area of the input connector. Between connection wires with basic insulation and touchable metal parts or the heat sink, a second insulation layer is required.

Within the light engine, the requirements for the creepage and clearance distances (to the mounting points and the edge of the light engine) for reinforced insulation are fulfilled. The requirements of creepage and clearance are automatically fulfilled when a touch protect accessory is applied.

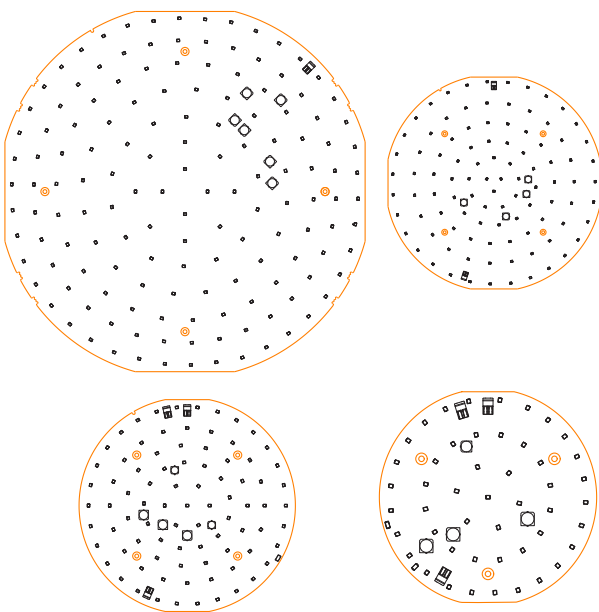

Orange lines show keep-out areas for sufficient creepage and clearance distances (relevant only without touch protect accessory)

4.3 Inrush current and system installation

Due to their electronic construction, PrevaLED® Flat AC G3 light engines have a minimum inrush current. In system installations, the number of light engines which can be attached to one circuit breaker is limited by the legal voltage drop regulations and the used cross-section of the connecting wires.

4.4 Electrostatic discharge (ESD)

PrevaLED® Flat AC G3 light engines fulfill the requirements of the immunity standard IEC/EN 61547. Please note that an electrostatic discharge exceeding 4–8kV HBM can cause damage, ranging from performance degradation to complete device failure. We recommend that all PrevaLED® Flat AC G3 light engines are handled and stored using appropriate ESD protection methods.

Please note: Handle with care!



4.5 Phase-cut dimming

The PrevaLED® Flat AC G3 PC version is dimmable with many leading-edge and trailing-edge phase-cut dimmers. Due to the integrated electronic control circuit, full compatibility with all available phase-cut dimmers cannot be ensured. For further and up-to-date information, please ask your sales partner or check our homepage on a regular basis: www.inventronics-light.com

4.6 Power as a function of voltage

The rated operating voltage of the light engine is 230V. The operating range is 220–240V. Concerning voltage variations, the light engine is tested according to IEC/EN 61000-3-3. Please note that the power of the light engine changes over the voltage range. Please have a look at the diagram below for the power as a function of voltage.

PrevaLED® Flat AC G3 (average guiding values for reference only)

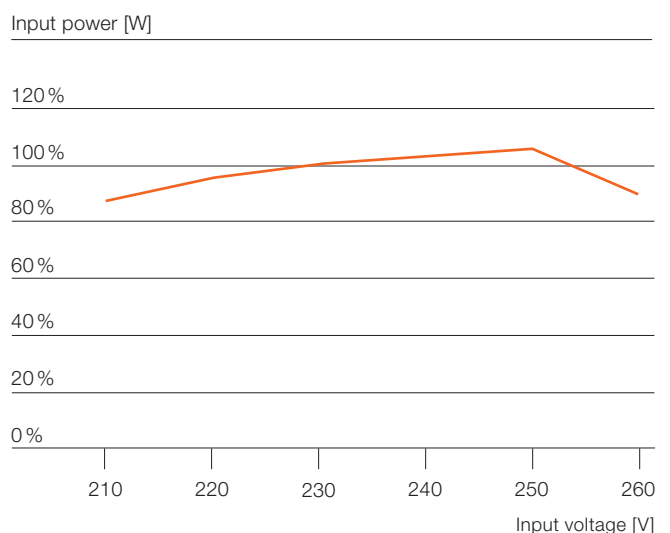

5 Thermal considerations

The proper thermal design of an LED luminaire is essential for achieving the best performance and ensuring the long-term lifetime of all components. Due to the high efficiency of PrevaLED® Flat AC G3 light engines, only a partial amount of the introduced electrical power has to be dissipated through the back of the light engine. The thermal power that has to be dissipated is given below.

5.1 Thermal power values

Product reference	Typical thermal power [W] ¹⁾	Maximum thermal power [W] ¹⁾
PL-FLAT-AC-PC-G3 1500-830	7.2	7.4
PL-FLAT-AC-PC-G3 1500-840	6.8	6.9
PL-FLAT-AC-PC-G3 2500-830	11.4	12.3
PL-FLAT-AC-PC-G3 2500-840	11.1	11.7
PL-FLAT-AC-PC-G3 3300-830	13.7	14.4
PL-FLAT-AC-PC-G3 3300-840	13.5	13.9
PL-FLAT-AC-PC-G3 4000-830	16.4	17.3
PL-FLAT-AC-PC-G3 4000-840	15.4	16.3
PL-FLAT-AC-MA-G3 1500-830	7.2	8.2
PL-FLAT-AC-MA-G3 1500-840	6.9	7.7
PL-FLAT-AC-MA-G3 2500-830	12.0	12.8
PL-FLAT-AC-MA-G3 2500-840	11.1	12.0
PL-FLAT-AC-SL-G3 1500-830	7.1	7.6
PL-FLAT-AC-SL-G3 1500-840	6.8	7.1
PL-FLAT-AC-SL-G3 2500-830	12.0	12.5
PL-FLAT-AC-SL-G3 2500-840	11.0	11.5
PL-FLAT-AC-EM-G3 1500-830	7.1	7.4
PL-FLAT-AC-EM-G3 1500-840	6.8	6.9
PL-FLAT-AC-EM-G3 2500-830	11.3	12.5
PL-FLAT-AC-EM-G3 2500-840	10.9	11.8
PL-FLAT-AC-EM-G3 3300-830	13.7	14.4
PL-FLAT-AC-EM-G3 3300-840	13.5	13.9
PL-FLAT-AC-DA-G3 1500-830	7.3	7.6
PL-FLAT-AC-DA-G3 1500-840	6.8	6.9
PL-FLAT-AC-DA-G3 2500-830	11.8	12.0
PL-FLAT-AC-DA-G3 2500-840	11.4	11.5
PL-FLAT-AC-DA-G3 4000-830	19.5	20.4
PL-FLAT-AC-DA-G3 4000-840	19.5	20.4
PL-FLAT-AC-DA-G3 5000-830	24.5	26.3
PL-FLAT-AC-DA-G3 5000-840	24.5	26.3

1) Value measured at the t_c point at a performance temperature (t_p) of 75 °C, input voltage of 230VAC/50Hz.

5.2 Thermal power as a function of voltage

Please note that the thermal power of the light engine is related to the applied line voltage. Please refer to the diagram in chapter 4.6.

5.3 Thermal derating

The integrated thermal protection feature serves to achieve the best possible lifetime and reliability of the light engine and to protect it from damage by overheating. The overheating protection or thermal derating, respectively, starts at a t_c point temperature of > 100 °C.

The curve in the graph below illustrates the mode of derating operation:

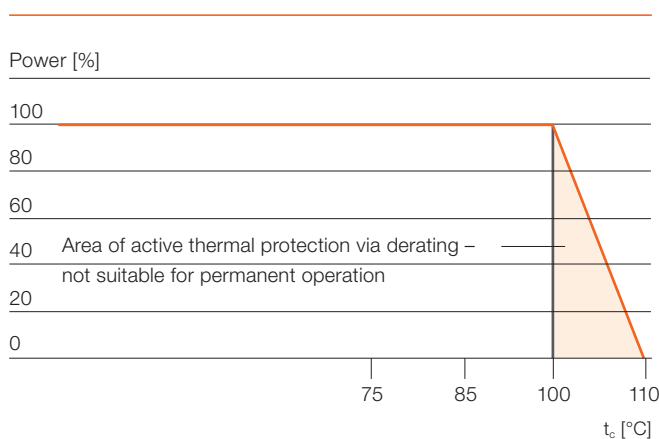

5.4 TIM and other accessories

Due to the high efficiency of the PrevaLED® Flat AC G3 light engine, the use of a thermal interface material (TIM) is not required. However, by using a TIM, an even better thermal connection of the light engine to the heat sink can be achieved.

Notes: A thermal design must always be confirmed by performing a thermal measurement in steady-state condition. PrevaLED® Flat AC G3 light engines do not necessarily need to be attached to a heat sink. Depending on the application, however, a suitable cooling solution (e.g. a heat sink or luminaire housing) might be needed to keep the t_c point temperature below the allowed maximum and therefore to ensure a safe operation.

5.5 t_c point location and temperature measurement

The t_c point is the reference location to check if the chosen luminaire construction is sufficient to ensure the LED light engine performance. The t_c point is located on the top side of the light engine (see pictures below).

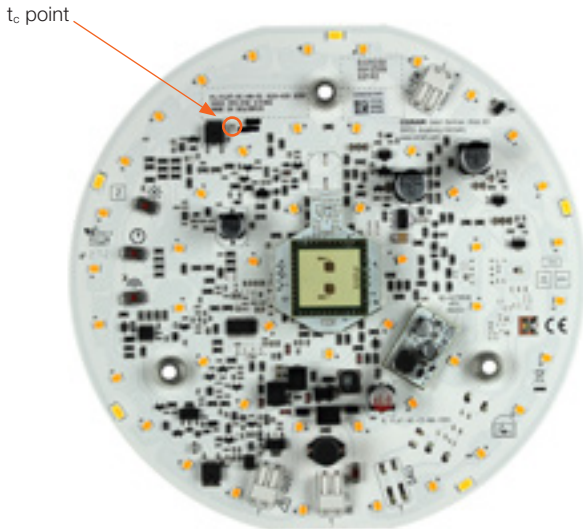

Note: The term t_c according to IEC 62031 stands for the highest permissible temperature, which may occur at the t_c point under normal operating conditions. The t_c point is the location where the temperature is measured (see picture above).

A correct temperature measurement can, for example, be performed with a thermocouple that can be glued onto the light engine. It should be ensured that the thermocouple is fixed with direct contact to the t_c point.

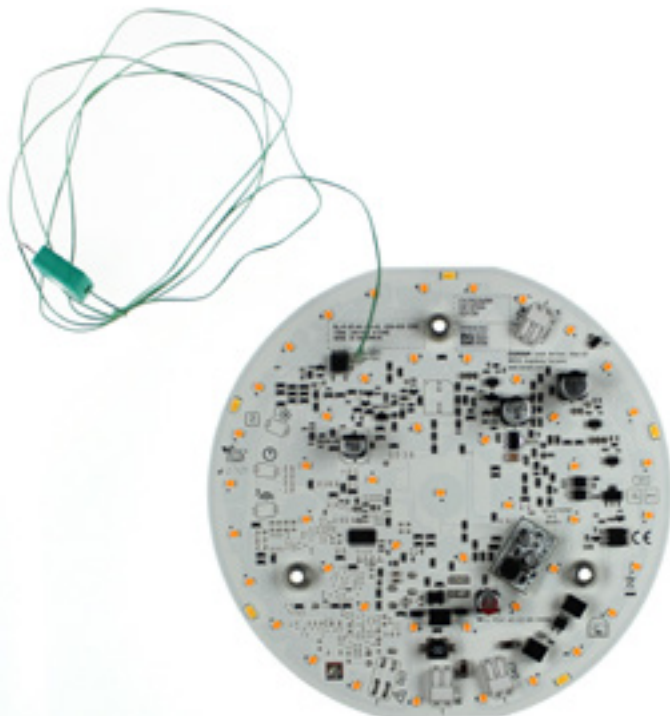

Mounting of a thermocouple

Note: Please keep in mind that a good thermal coupling is needed between the thermocouple and the PCB. Measurements to be carried out by skilled personnel only! Be aware that during the operation, the entire light engine is connected to mains voltage all the time!

Examples of suitable thermocouples:

K-type thermocouple with miniature connector



Different thermocouples

Illustration	Description	Temperature range [°C]
	PVC-insulated thermocouple	-10 ... +105
	PFA-insulated thermocouple	-75 ... +260

To ensure a direct contact between the thermocouple and the PCB, it is recommended to either glue the thermocouple onto the PCB or to solder it to the t_c point. You can, for example, use an acrylic glue, such as Loctite 3751.

6 Lifetime and thermal behavior

6.1 Cooling

PrevaLED® Flat AC G3 light engines do not necessarily need to be attached to a heat sink. Depending on the application, however, a suitable cooling solution (e.g. a heat sink or luminaire housing) might be needed to keep the t_c point temperature below the allowed maximum and thereby ensure a safe and reliable operation.

6.2 Luminous flux as a function of temperature

The luminous flux of PrevaLED® Flat AC G3 light engines depends on their temperature. 100 % of the luminous flux is achieved at the reference temperature of 75 °C ($t_r = 75$ °C). This temperature is referenced to the t_c point.

The luminous flux changes in relation to the reference temperature according to the following diagram.

Luminous flux as a function of temperature

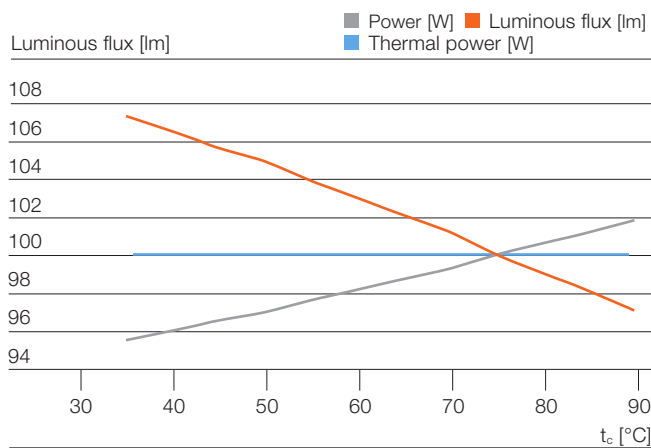

6.3 Lifetime as a function of temperature

For the definition of the lifetime of a light engine, please refer to IEC/PAS 62717, where the following types are defined (examples):

- **L0C10** is the lifetime where 10 % of a light engine batch failed abruptly during the tests.
- **L70B50** is the lifetime where the light output of 50 % of a light engine batch is ≥ 70 %. B value includes only gradual reduction of lumen output over time (not the abrupt failures).
- **L70F50** is the lifetime where the light output of 50 % of a light engine batch is ≥ 70 %. F value includes reduction of lumen output over time including abrupt failures (luminous flux = 0).

If the performance temperature (t_p) is maintained, PrevaLED® Flat AC G3 light engines have an average life-time of 50 000 hours (L70B50). The maximum temperature measured at the t_c point must not exceed 75 °C to achieve full lifetime.

Note: Higher temperatures lead to a shorter lifetime of the PrevaLED® Flat AC G3 light engines. Moreover, the failure rate will also increase.

The table below shows the lifetime of PrevaLED® Flat AC G3 light engines according to IEC/PAS 62717.

Lifetime overview based on: PL-FLAT-AC-MA/SL/DA-G3 1500-830/840 230V

t_p [°C] = 65	LxBy						LxCy		LxFy					
x	70		80		90		0		70		80		90	
y	10	50	10	50	10	50	10	50	10	50	10	50	10	50
LT	50000	50000	50000	50000	30000	35000	>130000	>130000	50000	50000	50000	50000	29000	35000

t_p [°C] = 75	LxBy						LxCy		LxFy					
x	70		80		90		0		70		80		90	
y	10	50	10	50	10	50	10	50	10	50	10	50	10	50
LT	50000	50000	50000	50000	28000	33000	92000	92000	50000	50000	50000	50000	27000	33000

t_p [°C] = 80	LxBy						LxCy		LxFy					
x	70		80		90		0		70		80		90	
y	10	50	10	50	10	50	10	50	10	50	10	50	10	50
LT	50000	50000	50000	50000	27000	32000	65000	65000	50000	50000	50000	50000	26000	32000

t_p [°C] = 85	LxBy						LxCy		LxFy					
x	70		80		90		0		70		80		90	
y	10	50	10	50	10	50	10	50	10	50	10	50	10	50
LT	50000	50000	50000	50000	26000	31000	46000	46000	46000	46000	46000	46000	26000	31000

t_p [°C] = 90	LxBy						LxCy		LxFy					
x	70		80		90		0		70		80		90	
y	10	50	10	50	10	50	10	50	10	50	10	50	10	50
LT	50000	50000	50000	50000	26000	30000	32000	32000	32000	32000	32000	32000	25000	30000

PL-FLAT-AC-PC_EM-G3 1500-830/840 230V

t_p [°C] = 65	LxBy						LxCy		LxFy					
x	70		80		90		0		70		80		90	
y	10	50	10	50	10	50	10	50	10	50	10	50	10	50
LT	50000	50000	50000	50000	30000	35000	>130000	>130000	50000	50000	50000	50000	30000	35000

t_p [°C] = 75	LxBy						LxCy		LxFy					
x	70		80		90		0		70		80		90	
y	10	50	10	50	10	50	10	50	10	50	10	50	10	50
LT	50000	50000	50000	50000	28000	33000	73000	73000	73000	73000	50000	50000	28000	33000

t_p [°C] = 80	LxBy						LxCy		LxFy					
x	70		80		90		0		70		80		90	
y	10	50	10	50	10	50	10	50	10	50	10	50	10	50
LT	50000	50000	50000	50000	27000	32000	52000	52000	52000	52000	50000	50000	27000	32000

t_p [°C] = 85	LxBy						LxCy		LxFy					
x	70		80		90		0		70		80		90	
y	10	50	10	50	10	50	10	50	10	50	10	50	10	50
LT	50000	50000	50000	50000	26000	31000	36000	36000	36000	36000	36000	36000	26000	31000

t_p [°C] = 90	LxBy						LxCy		LxFy					
x	70		80		90		0		70		80		90	
y	10	50	10	50	10	50	10	50	10	50	10	50	10	50
LT	50000	50000	50000	50000	26000	30000	26000	26000	26000	26000	26000	26000	25000	26000

PL-FLAT-AC-SL-G3 2500-830/840 230V

t_p [°C] = 65	LxB_y						LxC_y		LxF_y					
x	70		80		90		0		70		80		90	
y	10	50	10	50	10	50	10	50	10	50	10	50	10	50
LT	100000	100000	65000	73000	32000	35000	>130000	>130000	100000	100000	64000	73000	31000	35000

t_p [°C] = 75	LxB_y						LxC_y		LxF_y					
x	70		80		90		0		70		80		90	
y	10	50	10	50	10	50	10	50	10	50	10	50	10	50
LT	96000	100000	61000	68000	30000	33000	>130000	>130000	92000	100000	59000	68000	29000	33000

t_p [°C] = 80	LxB_y						LxC_y		LxF_y					
x	70		80		90		0		70		80		90	
y	10	50	10	50	10	50	10	50	10	50	10	50	10	50
LT	93000	100000	59000	66000	29000	32000	>130000	>130000	87000	100000	57000	66000	28000	32000

t_p [°C] = 85	LxB_y						LxC_y		LxF_y					
x	70		80		90		0		70		80		90	
y	10	50	10	50	10	50	10	50	10	50	10	50	10	50
LT	90000	100000	57000	64000	28000	31000	92000	92000	83000	92000	55000	64000	27000	31000

t_p [°C] = 90	LxB_y						LxC_y		LxF_y					
x	70		80		90		0		70		80		90	
y	10	50	10	50	10	50	10	50	10	50	10	50	10	50
LT	88000	99000	55000	62000	27000	30000	65000	65000	65000	65000	52000	62000	26000	30000

PL-FLAT-AC-MA-G3 2500-830/840 230V

t_p [°C] = 65	LxB_y						LxC_y		LxF_y					
x	70		80		90		0		70		80		90	
y	10	50	10	50	10	50	10	50	10	50	10	50	10	50
LT	100000	100000	65000	73000	32000	35000	>130000	>130000	100000	100000	64000	73000	31000	35000

t_p [°C] = 75	LxB_y						LxC_y		LxF_y					
x	70		80		90		0		70		80		90	
y	10	50	10	50	10	50	10	50	10	50	10	50	10	50
LT	96000	100000	61000	68000	30000	33000	>130000	>130000	91000	108000	59000	68000	29000	33000

t_p [°C] = 80	LxB_y						LxC_y		LxF_y					
x	70		80		90		0		70		80		90	
y	10	50	10	50	10	50	10	50	10	50	10	50	10	50
LT	93000	100000	59000	66000	29000	32000	103000	103000	87000	103000	57000	66000	28000	32000

t_p [°C] = 85	LxB_y						LxC_y		LxF_y					
x	70		80		90		0		70		80		90	
y	10	50	10	50	10	50	10	50	10	50	10	50	10	50
LT	90000	100000	57000	64000	28000	31000	73000	73000	73000	73000	54000	64000	27000	31000

t_p [°C] = 90	LxB_y						LxC_y		LxF_y					
x	70		80		90		0		70		80		90	
y	10	50	10	50	10	50	10	50	10	50	10	50	10	50
LT	88000	99000	55000	62000	27000	30000	51000	51000	51000	51000	51000	51000	26000	30000

PL-FLAT-AC-PC/EM-G3 3300-8y0 230V

t_p [°C] = 65	LxBBy						LxCy		LxFy					
x	70		80		90		0		70		80		90	
y	10	50	10	50	10	50	10	50	10	50	10	50	10	50
LT	100000	114000	64000	72000	31000	34000	>130000	>130000	98000	100000	63000	71000	31000	34000

t_p [°C] = 75	LxBBy						LxCy		LxFy					
x	70		80		90		0		70		80		90	
y	10	50	10	50	10	50	10	50	10	50	10	50	10	50
LT	94000	106000	59000	67000	29000	32000	96000	96000	89000	96000	58000	67000	28000	32000

t_p [°C] = 80	LxBBy						LxCy		LxFy					
x	70		80		90		0		70		80		90	
y	10	50	10	50	10	50	10	50	10	50	10	50	10	50
LT	91000	100000	58000	65000	28000	31000	68000	68000	68000	68000	56000	64000	27000	31000

t_p [°C] = 85	LxBBy						LxCy		LxFy					
x	70		80		90		0		70		80		90	
y	10	50	10	50	10	50	10	50	10	50	10	50	10	50
LT	88000	100000	56000	63000	27000	30000	48000	48000	48000	48000	48000	48000	26000	30000

t_p [°C] = 90	LxBBy						LxCy		LxFy					
x	70		80		90		0		70		80		90	
y	10	50	10	50	10	50	10	50	10	50	10	50	10	50
LT	86000	97000	54000	61000	26000	29000	34000	34000	34000	34000	34000	34000	26000	29000

PL-FLAT-AC-PC-G3 4000-830/840 230V

t_p [°C] = 65	LxBBy						LxCy		LxFy					
x	70		80		90		0		70		80		90	
y	10	50	10	50	10	50	10	50	10	50	10	50	10	50
LT	100000	100000	63000	71000	31000	34000	>130000	>130000	96000	100000	62000	71000	30000	34000

t_p [°C] = 75	LxBBy						LxCy		LxFy					
x	70		80		90		0		70		80		90	
y	10	50	10	50	10	50	10	50	10	50	10	50	10	50
LT	94000	100000	59000	66000	29000	32000	106000	106000	85000	100000	57000	66000	28000	32000

t_p [°C] = 80	LxBBy						LxCy		LxFy					
x	70		80		90		0		70		80		90	
y	10	50	10	50	10	50	10	50	10	50	10	50	10	50
LT	91000	100000	57000	64000	28000	31000	75000	75000	75000	75000	54000	64000	27000	32000

t_p [°C] = 85	LxBBy						LxCy		LxFy					
x	70		80		90		0		70		80		90	
y	10	50	10	50	10	50	10	50	10	50	10	50	10	50
LT	88000	99000	55000	62000	27000	30000	53000	53000	53000	53000	51000	53000	26000	30000

t_p [°C] = 90	LxBBy						LxCy		LxFy					
x	70		80		90		0		70		80		90	
y	10	50	10	50	10	50	10	50	10	50	10	50	10	50
LT	85000	96000	54000	60000	26000	29000	37000	37000	37000	37000	37000	51000	25000	29000

7 Mechanical considerations

7.1 Outline drawings

The following schematic drawings (all dimensions in mm, slight deviations possible) provide further details of the dimensions of PrevaLED® Flat AC G3 light engines. For 3D files of the light engines, please see www.inventronics-light.com.

Outline drawings exemplary for Master/Slave versions (with touch protect accessory)

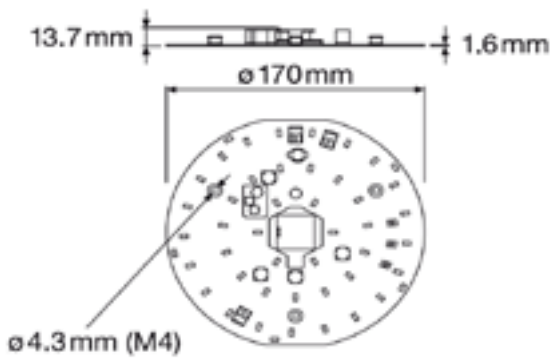

PL-FLAT-AC-MA-G3 1500-840 230V

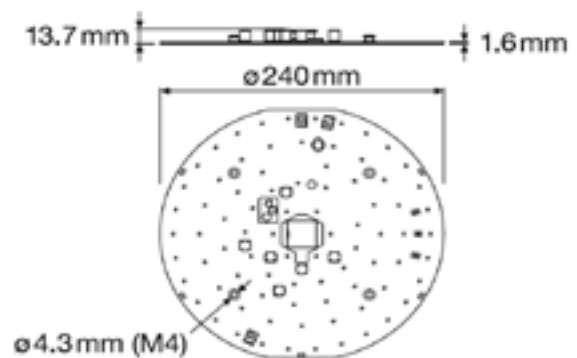

PL-FLAT-AC-MA-G3 2500-840 230V

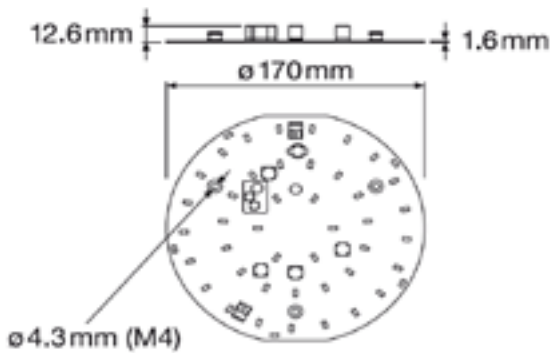

PL-FLAT-AC-SL-G3 1500-840 230V

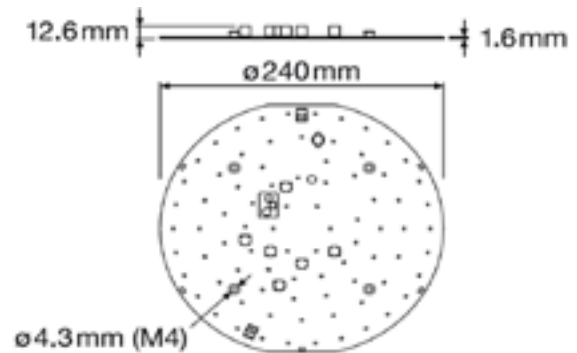

PL-FLAT-AC-SL-G3 2500-840 230V

7.2 Mechanical protection of the light engine

PrevaLED® Flat AC G3 light engines should not be exposed to strong mechanical stress. Please apply force only to the dedicated mounting positions (see 7.5). Strong mechanical stress can lead to irreversible damage of the light engine.

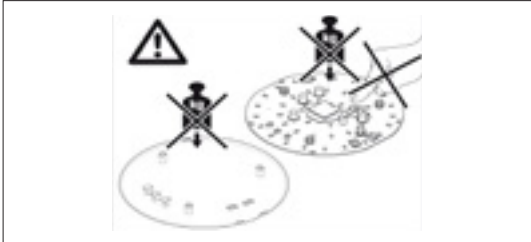

Note: Do not touch or mechanically stress any component of the light engine. This could damage the light engine.

7.3 Touch protect accessory

To protect the light engine from contact and to provide a basic insulation, additional touch protection accessories are available for the PrevaLED® Flat AC G3 light engine family.

The touch protect accessory for the MA version shall be used in order to have safe access to the push-buttons on the light engines. To push the setting buttons when the touch protect accessory is mounted, use a crosstip screwdriver.

Note: In combination with the touch protect accessory, a PrevaLED® Flat AC G3 light engine has reinforced insulation on the back and basic insulation on the top.

3D pictures of the touch protect accessory



PL-FLTP 170 G3



PL-FLTP 240 G3



PL-FLTP 170 MA G3



PL-FLTP 240 MA G3

The height of a PrevaLED® Flat AC G3 light engine with assembled touch protect accessory is 22.15 mm.

Note: Due to the regulations of IEC 60598-1, the touch protect accessory cannot be removed without destruction.

7.4 Protection from corrosion

To protect electronic parts (such as LEDs) from corrosion, a corrosive atmosphere around the components has to be avoided. In case of LEDs, H₂S, for example, is a highly corrosive substance which can lead to a drastically shortened product lifetime. The source for H₂S are sulfur-cross-linked polymers, such as rubber. To ensure the absence of H₂S, it is recommended to use peroxide-cross-linked materials, which are available on the market as an alternative to sulfur-cross-linked versions. Avoidance of corrosion by moisture has to be ensured by the appropriate protection of the luminaire housing (see chapter 3 “Ingress protection”).

7.5 Mounting

To mount a PrevaLED® Flat AC G3 light engine (with or without touch protect accessory), use M4 cylinder head screws according to DIN 912 or ISO 4762. The torque shall be 1.0 (±0.5)Nm.

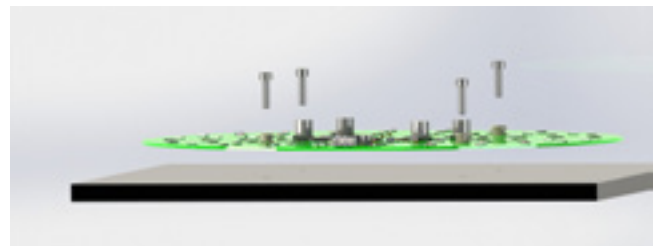

Mount PrevaLED® Flat AC G3 from the top

It is also possible to mount the touch protect accessory after the PrevaLED® Flat AC G3 light engine has been screwed to the heat sink/luminaire. Please refer to the insulation requirements in chapter 4.2.



PrevaLED® Flat AC G3 with touch protect accessory

8 PL-FLAT-AC emergency lighting

For the emergency-lighting-capable versions, a distinction must be made between emergency lighting for single battery systems with local power supply (L-EM) and emergency lighting with central battery systems (C-EM) according to IEC 60598-2-22.

8.1 Local emergency (L-EM)

For applications requiring emergency or stand-by lighting, the PrevaLED® Flat AC G3 series offers local emergency versions that allow the connection to a local battery system. These versions carry an additional, separate LED circuit for operation with local battery packs.

Within the Master/Slave system, also the Slaves are L-EM-capable. In this case, all local battery packs have to be supplied separately; supplying the battery packs via the Master-out is not allowed. Wiring set-up for the L-EM-capable PrevaLED® Flat AC G3 versions in an MA/SL system:

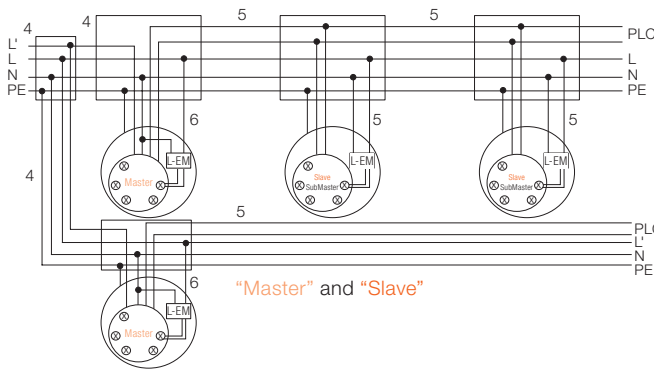

Application: Emergency lighting for single battery systems

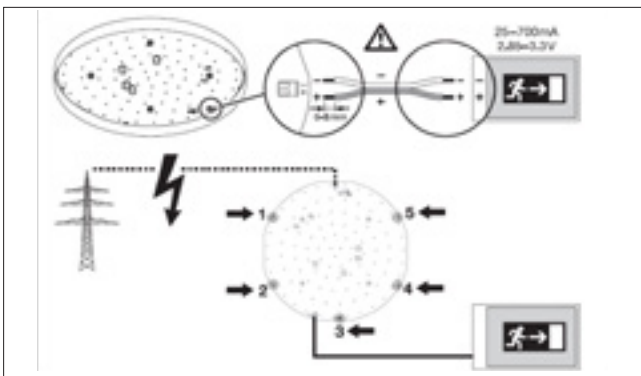

Notes:

- Please mind the polarity of the emergency input, do not invert + and -. Inverted currents exceeding 1 A would destroy the device!
- Do not apply mains voltage to the L-EM input connector, this would destroy the device.
- The emergency lighting circuit can handle an input current in a range from 25 mA to 700 mA.

- The resulting voltage range extends from 2.2 V (at 25 mA, 85 °C) to 3.5 V (at 700 mA, 0 °C).
- The L-EM circuit shows double/reinforced insulation against mains voltage.
- The L-EM circuit has to be connected to a current source; do not use a voltage source.

The diagrams below show the typical luminous flux and forward voltage of the L-EM circuit as a function of the applied current.

Luminous flux as a function of current

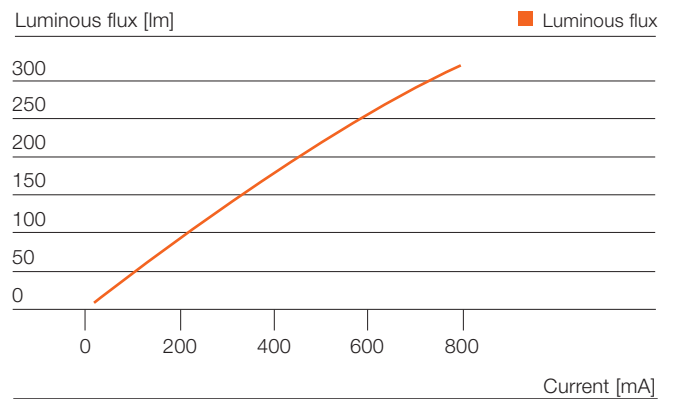

Forward voltage as a function of current

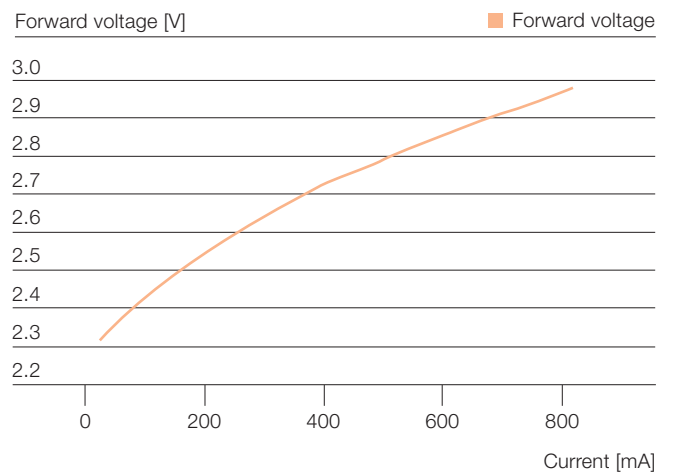

Local battery systems can, for example, be obtained from the suppliers listed below.

Exemplary suppliers of local battery systems

Alvit	www.alvit.it
ELP Emergency Lighting Products	www.elp.uk.com
Mackwell Electronics	www.mackwell.com

8.2 Central emergency (C-EM)

8.2.1 General

For central emergency operation applications, the PrevaLED® Flat AC G3 series offers versions comprising means that enable a DC voltage operation of the light engine in the range of 176 to 276 VDC and also an operation with rectified mains (Joker-Voltage). If such voltages are applied, the C-EM operation mode of the light engine is activated, characterized by the deactivation of a portion of the LEDs.

Application: Luminaires for emergency lighting with central battery according to IEC 60598-2-22

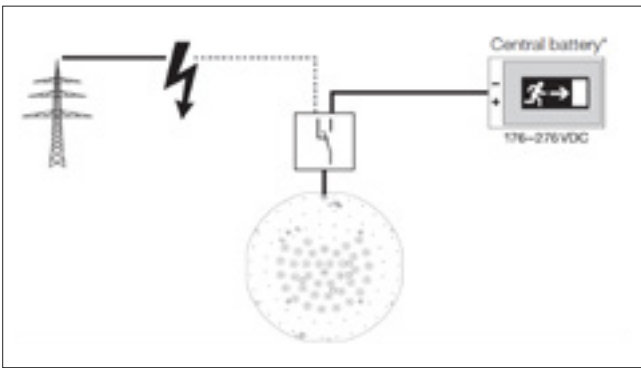

PrevaLED® Flat AC – PL-FLAT-AC-EM 230 V

8.2.2 PrevaLED® Flat AC G3 Master/DALI versions

To react to an emergency situation, the integrated C-EM circuitry in the PrevaLED® Flat AC MA and DA G3 versions detects the applied input voltage. In case of an applied DC voltage or a rectified mains voltage (Joker-Voltage), the PrevaLED® Flat AC MA and DA G3 versions automatically switch to C-EM operation mode.

Note: If AC mains voltage from the central battery system is applied to the PrevaLED® Flat AC MA G3 in case of a localized power failure, the sensor is still active and the PrevaLED® Flat AC MA G3 switches according to the sensor detection like in normal operation.

In C-EM operation mode with applied DC voltage, the light output is fixed at 25 % of the rated value. The input current does not depend on the applied DC supply voltage. The power consumption is shown in the graphs below:

1500lm versions (at $t_p = 75^\circ\text{C}$)

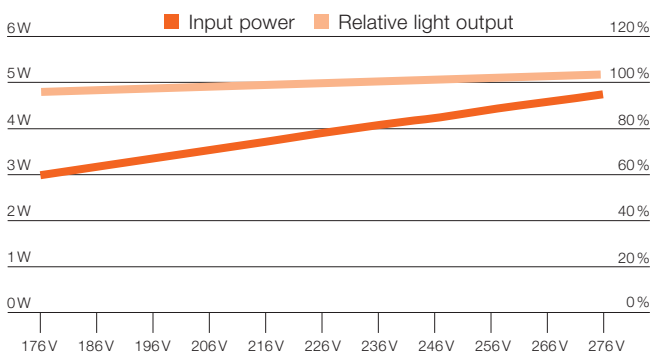

2500lm versions (at $t_p = 75^\circ\text{C}$)

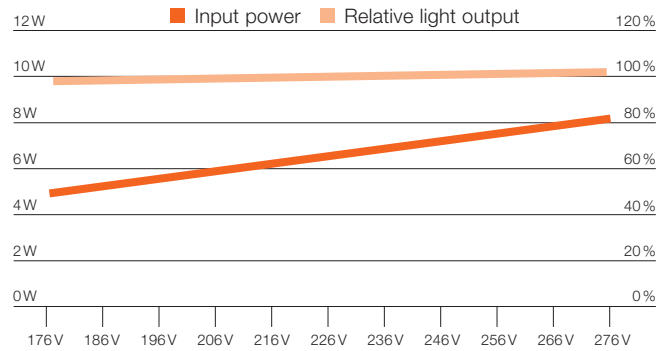

In Master/Slave configurations, only the Master operates in C-EM mode in case of emergency. All devices connected to the Master (Master-out connector) will not be supplied with electricity (case of emergency = applied DC or Joker-Voltage).

8.2.3 PrevaLED® Flat AC G3 Slave versions

SL versions are not C-EM-capable. In case of an applied DC voltage or a rectified mains voltage (Joker-Voltage), the PrevaLED® Flat AC G3 Slave automatically switches off.

8.2.4 PrevaLED® Flat AC G3 emergency versions

In case of an applied DC voltage, the PrevaLED® Flat AC EM G3 automatically switches to its C-EM operation mode. In case of an applied rectified mains voltage (Joker-Voltage), the PrevaLED® Flat AC EM G3 operates in nominal mode.

In C-EM operation mode with applied DC voltage, the light output is fixed at 25 % of the rated value. The input current does not depend significantly on the applied DC supply voltage. The power consumption is shown in the graphs below:

1500lm versions (at $t_p = 75^\circ\text{C}$)

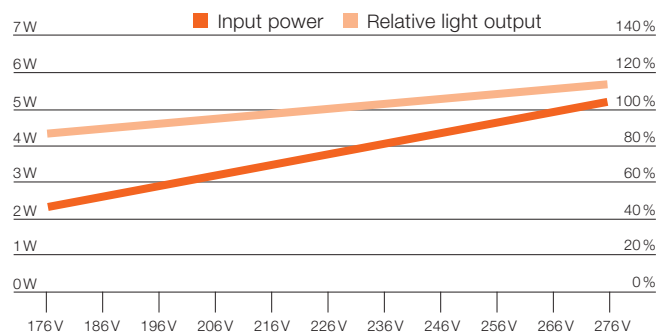

2500lm versions (at $t_p = 75^\circ\text{C}$)

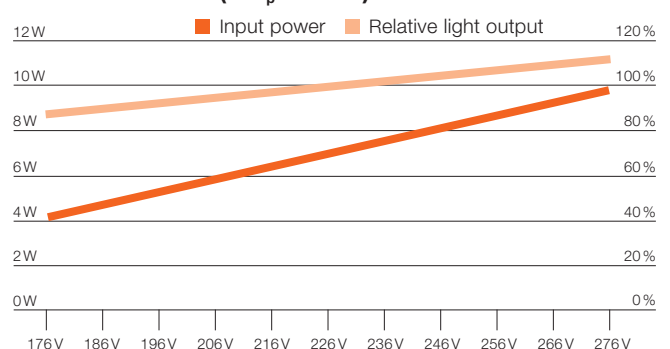

9 PL-FLAT-AC MA functionality

9.1 General information

The PrevaLED® Flat AC MA G3 has an integrated motion detector and a sensor which measures the ambient light of the light engine during its “off” state.

To enable the operation of the motion detector in almost every type of luminaire, an HF-based technology is used which operates with a frequency of 24 GHz. With this frequency, unintended triggering caused by motions in neighbored areas is negligible because the transmissibility of materials usually applied in buildings is too low (operation of this motion detector fulfills requirements according to EN 300440-1/-2).

Using the integrated ambient light sensor, the light-up of the light engine triggered by a detected motion can be prevented when the ambient light level is above an adjustable threshold. Six different thresholds can be adjusted (see chapter 9.6).

To configure the devices according to the needs of the application, three buttons are provided that serve to set parameters concerning the motion detection sensibility, the hold time and the threshold level for the ambient light measurement.

Moreover, by pressing the buttons for a longer time (3 seconds), advanced setting parameters can be addressed.

9.2 User interface

The picture below shows the positions of the buttons for commissioning:

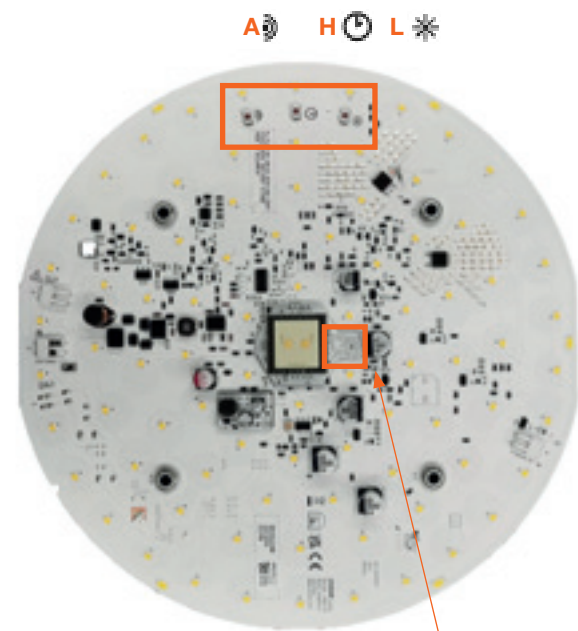

- A Button “Area”
 - H Button “Hold time”
 - L Button “Light level threshold”
- “A”, “H” or “L” is shown on display

9.3 Commissioning

For the commissioning of the PrevaLED® Flat AC MA G3, follow these steps:

- Connect luminaire to mains, luminaire lights up to 100%.
- Press any button to switch to commissioning mode, luminaire dims down immediately to 5% to avoid glare.



- Simple set-up – 3 buttons for 3 functions:

A	H	L
Area	Hold time	Light level threshold



9.4 Motion detection sensibility, detection area

The area that is monitored by the light engine can be adjusted to seven different levels by using the button “Area”. The factory setting for “Area” is level 5 resulting in 90% coverage of the maximum detection area.



- Press the button [A] “Area” to change the range of the detection area

Note: Metallic or other improper cover materials as well as thickness and textures of the cover can cause a weakening or distortion of the motion detection.



9.5 Hold time

The hold time in which the light engine remains activated after the latest motion has been detected can be adjusted to eight different levels by using the button “Follow-up time”. Any further detected motion restarts the “Hold time”. The factory setting for “Hold time” is level 1, resulting in a hold time of 10 seconds.

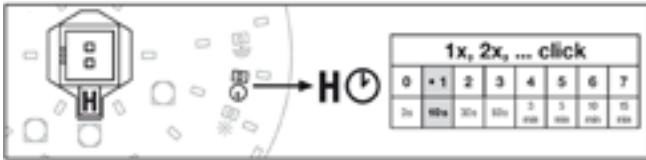

→ Press the button [H] “Hold time” to set the time the luminaire remains switched on after the latest detected motion.



9.6 Ambient light level threshold

9.6.1 Adjustment of the threshold in steps

The threshold for the ambient light level that must be exceeded to prevent the light engine from unintended light-up can be adjusted to seven different levels by using the button “Light level threshold”:

The factory setting for the light level threshold is level 0, resulting in a deactivated ambient light measurement (light engine lights up always when motion is detected).

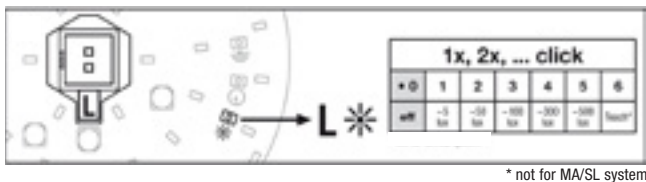

→ Press the button [L] “Light level threshold” to set the threshold for ambient light.

9.6.2 Adjustment of the threshold by “teach mode”

To trim the light engine performance perfectly to the needs of the application, the “teach mode” can be chosen to fix the threshold for the ambient light that must be exceeded to prevent the light engine from unintended light-up.

Activation of the “teach mode”:

Press the button [L] “Light level threshold” for 3 seconds; the display of the PrevaLED® Flat AC MA G3 shows “P”. After that, release and press the button one time; the display changes from “0” to “1”, which indicates that the learning procedure is activated. The light output will remain on its minimum level (5 %) for 1 minute, the display shows a blinking “P” to signalize the activated “teach mode”. During this time, the cover of the luminaire shall be mounted correctly. After this time has expired, the light will turn off for roughly 1 s to measure the ambient light of the luminaire and to adjust and save this brightness level as threshold (value remains accessible on level 6). Finally, when the measurement is completed, the light output will return to 100 %. During the measurement procedure, any unusual shadowing or illumination shall be avoided.

The learnt threshold level is permanently stored and accessible on level 6 until another value is learnt by repetition of the described procedure, even if temporarily other threshold levels (e.g. level 4) were activated.

9.7 Corridor Function

The Corridor Function allows to configure the PrevaLED® Flat AC MA G3 in a way that it operates continuously with 10 % light level when no motion is detected. This is recommended for applications without any ambient light, e.g. in corridors without daylight.

To activate the Corridor Function, press the button [H] “Hold time” for 3 seconds until the display shows “P”. Press button [H] again for choosing the level (see table below). The PrevaLED® Flat AC MA G3 provides three levels for the Corridor Function:

Corridor Function level options

	Sequence of light output after being triggered:
Level 0:	100 % (hold time) → 10 % (10 s) → 0 % (= factory setting)
Level 1:	100 % (hold time) → 10 %
Level 2:	100 % (hold time) → 10 % (Xs = “H”) → 0 %

9.8 Factory reset

The device can be reset to factory settings by pressing the buttons [A] “Area” and [H] “Hold time” simultaneously for 3 seconds; the display shows “F”. A short disappearance of the “F” indicates a successful reset. Afterwards, the buttons may be released.

10 PL-FLAT-AC Master/Slave system

10.1 PrevaLED® Flat AC G3 Master/Slave system

In order to illuminate larger areas than a single PrevaLED® Flat AC G3 Master can monitor, PrevaLED® Flat AC G3 Slaves can be connected to the PrevaLED® Flat AC G3 Master. The motion detection performance and the mode of operation of the PrevaLED® Flat AC G3 Master is explained in chapter 9. The connected Slaves are controlled by the Master and operate in the same way. If it is required to monitor a larger area than a single Master can cover, e.g. in long corridors, up to four Masters can be connected in parallel to the Slaves to the Master which is directly connected to mains.

Note: Concerning emergency lighting performance of a PrevaLED® Flat AC G3 Master/Slave system, see chapter 8.

10.2 Wiring set-up

The wiring of a PrevaLED® Flat AC G3 Master/Slave system is simply realized by connecting one Master directly to the mains which makes this Master the main Master of the system. All other devices such as Slaves or further Masters must be connected to the Master-out connector of the main Master. Further Masters operate as sub-Masters when connected to the output of the main Master.

Note: Applying mains voltage to the Master-out terminal destroys the device.

PrevaLED® Flat AC G3 Master/Slave wiring set-up

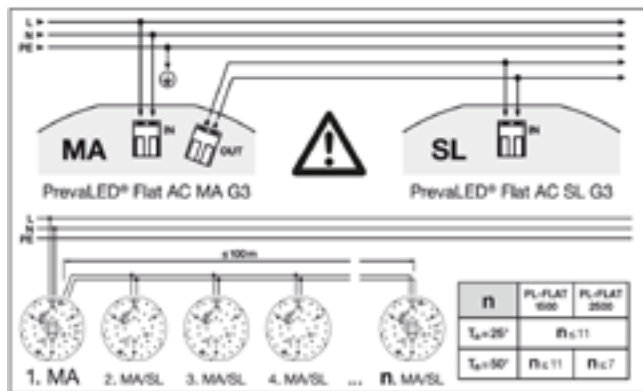

Please also consider the notes in chapter 8.1.

10.3 Connectable load

The PrevaLED® Flat AC G3 Master 1500lm is designed to control a maximum load of 150W.

Maxi load in one MA-SL 1500lm system:
1MA + 10MA/SL

The PrevaLED® Flat AC G3 Master 2500lm is designed to control a maximum load of 230W.

ta=25°C: Max load in one MA-SL 2500lm system:
1MA + 10MA/SL

ta=50°C: Max load in one MA-SL 2500lm system:
1MA + 6MA/SL

If a higher load is connected to the Master-out connector, the device switches off the load (overload protection).

Note: Connecting other devices than PrevaLED® Flat AC G3 Masters or Slaves can destroy the device. This also includes charging units for L-EM systems (see also chapter 8).

10.4 Operation mode

The PrevaLED® Flat AC G3 Master has the following functions:

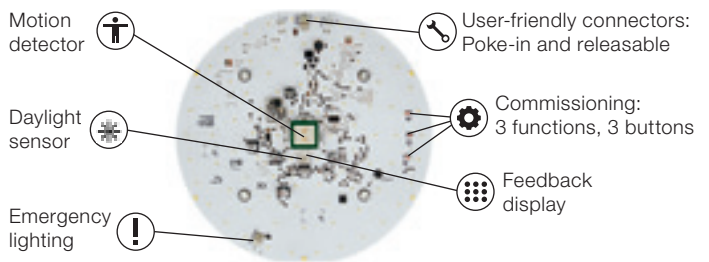

For detailed information, please see chapter 9.

10.4.1 Operation of a PrevaLED® Flat AC G3 Master/Slave system comprising one Master

The PrevaLED® Flat AC G3 Master is configured and operates as explained in chapter 9. If the Master detects a motion inside its detection area and the ambient brightness is below the adjusted threshold, it sends a command to all connected Slaves to light up and the Master and the Slaves light up simultaneously. After passing the adjusted hold time, the Master and all the Slaves reduce their light output and switch off.

10.4.2 Operation of a PrevaLED® Flat AC G3 Master/Slave system comprising two or more Masters

All PrevaLED® Flat AC G3 Masters of a system operate as explained in chapter 9, but the setting of the following parameters is not possible for any sub-Master and the respective menu levels cannot be addressed:

Hold time

The hold time of the system can only be adjusted at the main Master. When pressing the “hold time” button at a sub-Master, its display continuously shows “0”.

Corridor Function

The activation of the Corridor Function can only be done at the main Master. When trying to activate the Corridor Function at a sub-Master, the respective menu level (see chapter 9.7) is disabled.

Luminaire mode

A sub-Master cannot be set to luminaire mode. The respective menu level (see chapter 10.5) is disabled.

Teach mode for ambient light threshold

The teach mode is not activated for Master/Slave systems.

Deactivation of motion detection

If motion detection is deactivated at the main Master, all light engines operate as on/off modules.

If motion detection is deactivated at a sub-Master, it operates as a Slave (motion detection deactivated).

In the “off” state, all Masters continuously measure their ambient light level, the sub-Masters send an according information to the main Master.

When the Corridor Function is activated, the light engine never switches off, and the light measurement is automatically and permanently deactivated.

The main Master and all sub-Masters continuously monitor whether a motion happens inside their detection area. Whenever a low light level is measured at any of the Masters and a motion is detected anywhere in the system, the light is switched on simultaneously. Low light level measurement and motion detection must not necessarily be at the same position. If the ambient light measurement is deactivated at one or more Master light engines (see chapter 9), all ambient light levels are ignored and the system lights up when any motion is detected in the system.

Note: When buttons are pressed at any sub-Master, only this sub-Master temporarily switches to dimmed operation (glare protection; see chapter 9.3).

10.5 Multiple light engines in one luminaire – luminaire mode

A maximum of three light engines can be mounted in one luminaire. To minimize the power consumption of a luminaire in its “off” state when it comprises more light engines than only one Master (e.g. one Master and two Slaves), the luminaire mode can be chosen. When activating the luminaire mode, the Master disconnects the power supply for the Slaves. Result: The whole system works fine but with less stand-by power consumption.

In the improbable case that a luminaire equipped with multiple PrevaLED® Flat AC G3 light engines does show excessive RFI levels (acc. to EN 55015), it is recommended to implement an X2 capacitor which is connected to the input terminals of the luminaire.

For further information, please ask your sales partner.

10.6 Identification of Master and sub-Master/s in existing installations

The main Master can be identified by the fact that the entire system dims down when any of this Master’s buttons are pressed (see chapter 9.3).

Any sub-Master can be identified by the fact that only this light engine dims down when any of its buttons are pressed (see chapter 9.3).

11 PL-FLAT-AC DALI

11.1 Introduction

Your interface to the future

DALI devices for intelligent lighting solutions are powerful, efficient and multifunctional.



Creating fascinating settings with light

With the right lighting solution, one can express one's individuality in various ways and perform many different tasks: Rooms are brought to life with ease, general safety is increased and the quality of workplace illumination is improved. Our sophisticated and reliable solutions meet all these requirements and, thanks to state-of-the-art lighting control, achieve the highest levels of energy efficiency and individuality. Moreover, they also provide an optimal price-performance ratio while covering a wide spectrum – from simple applications to complex installations with light management systems.

DALI standard and much more

Dimmable digital power supplies with DALI interfaces provide optimum conditions for achieving the highest possible energy efficiency and flexibility. With the second generation of our DALI devices, we have even surpassed the common DALI standard – with cutting-edge functions that offer unique advantages in a great variety of applications:

- Increase of energy efficiency in storage and production areas in the industrial sector
- Brilliance and individuality in the sales and hospitality sectors
- Flexibility and motivation in office areas
- Multifunctional and flexible wide-area lighting, e.g. in sports halls and parking garages

With our unique digital functions, you can meet today's standards down to the last detail, thus strengthening your position in the lighting market while being best prepared for the requirements of tomorrow. The functions that will be described in detail on the following pages include:

- Touch DIM® function: Comfortable dimming with standard push-buttons
- Corridor Function: Direct use of standard motion sensors
- SMART GRID function: Easy monitoring of lighting systems

11.2 Additional functions integrated in PL-FLAT-AC-DA-G3

11.2.1 Touch DIM®



Often it's the easy solutions that save costs and energy. This is also true for the Touch DIM® function: The comfortable dimming of up to 20 light engines, e.g. in conference rooms or single offices, is controlled via standard push-buttons and therefore keeps investment costs low. Connected to mains voltage, each action is triggered by short and/or long push-button pulses. In combination with a Touch DIM® sensor, daylight can also be used, resulting in additional energy savings.

The benefit of the Touch DIM® function

The Touch DIM® function allows for free parametrization of threshold values. In a single office, for example, the lighting can be completely switched off during lunch breaks thanks to the unique stand-by operation.



Touch DIM® LS/PD LI sensor, Touch DIM® LS LI sensor

Synchronization of Touch DIM®

If a large number of PrevaLED® Flat AC G3 DALI with Touch DIM® is operated in a system, there is a chance that a PrevaLED® Flat AC G3 DALI will operate out of synchronism with the others (= different dimming level setting or different switching state).

Synchronism can be restored as follows:

- Step 1:** Long press of the push-button (> 0.5 s): All the lamps are switched on
- Step 2:** Short press of the push-button (< 0.5 s): All the lamps are switched off
- Step 3:** Long press of the push-button (> 0.5 s): All the lamps are switched on at minimum dimmer setting and fade up
- Step 4:** Double-click (2x within 0.4 s) to store value (optional)

After the first three steps – long-short-long – all PrevaLED® Flat AC G3 DALI will be back in synchronism.

Note: Touch DIM® is designed for manual control; it is not suitable for a connection to an automation.

11.2.2 Corridor Function



Description of the Corridor Function

It is possible to connect the PrevaLED® Flat AC G3 DALI directly to commercially available motion sensors. The Corridor Function is triggered by a switching signal, i.e. the voltage of the supply line (220–240V, 50/60Hz) is applied to the DALI control line inputs (DA; see the diagram below). A preset “out-of-the-box” luminous flux program launches upon triggering. This can be individually adjusted via OSRAM Tuner4TRONIC® and DALI magic. Three light value ranges and six time ranges are available for this purpose.

Advantage:

Development of new applications (stairwells, corridors, large storage facilities etc.) with the possibility of saving energy and achieving high energy efficiency.

OSRAM DALI ECG wiring diagram for Corridor Function

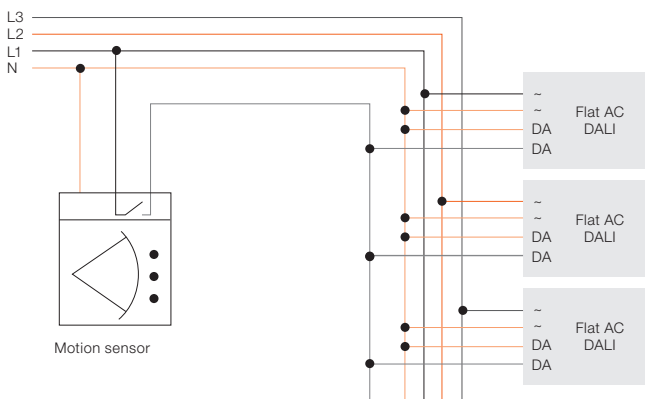

Note: The default setting of PrevaLED® Flat AC G3 DALI is the Touch DIM® mode. In order to change the parameters or to switch to the Corridor Function, please use the Tuner4TRONIC® software tool. Please note that PrevaLED® Flat AC G3 DALI light engines in Corridor Function can only be combined with other DALI 2 LED light engines or control gears.

11.2.3 SMART GRID function



With the SMART GRID function, lighting systems can be easily monitored and successfully operated. The function increases the level of service by enabling, for example, the readout of the light sources’ operating hours, thus facilitating the scheduling of service intervals.

Overview of supported SMART GRID functions

Operation time	Supported
Operation temperature*	Not supported
Temperature time integration*	Not supported
Overvoltage detection	Supported
Power consumption	Supported
EOL (end of life)	Not supported

*Not supported means not necessary since the light engine protects itself.

11.3 Digital programming and parametrization options

11.3.1 General

PrevaLED® Flat AC G3 DALI light engines can be programmed using the Tuner4TRONIC® (T4T) software together with the hardware programmer DALI magic.

- Tuner4TRONIC Configurator is a browser base application on Google Chrome or Mozilla Firefox.
- Tuner4TRONIC Configurator allows creating production files with parameter settings – e.g. output current, operating mode, dim profiles.
- Tuner4TRONIC Production 4 is a WINDOWS based application to program and read LED drivers.

Please download the software for free here:
www.inventronics-light.com/t4t

For more information on the programming of PrevaLED® Flat AC G3 DALI, please consult the Tuner4TRONIC® manuals.

Light engine programming

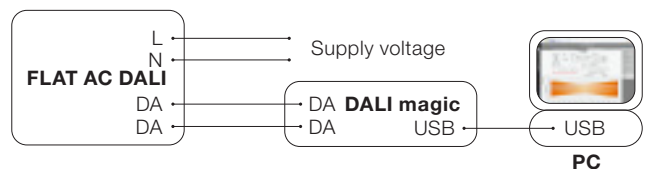

During programming, PrevaLED® Flat AC DALI light engines need to be supplied with mains input voltage. The low voltage of the DALI bus allows for safe programming without the need for additional precautions during production.

11.3.2 Parametrization by Tuner4TRONIC® software

As with all other OSRAM DALI devices, it is possible to change, edit and set all DALI parameters of the PrevaLED® Flat AC G3 DALI by use of the Tuner4TRONIC® software tool.

Features such as the Touch DIM® sensor and the Corridor Function remain exactly the same as with all our other devices. Nevertheless, due to the integrated LEDs of PrevaLED® Flat AC G3 DALI, a transformation of input parameters for luminous flux has to be made.

Tuner4TRONIC® defines current inputs (not light levels) for the PrevaLED® Flat AC G3 DALI.

It is therefore necessary to reinterpret the data to set a certain maximum operating light level.

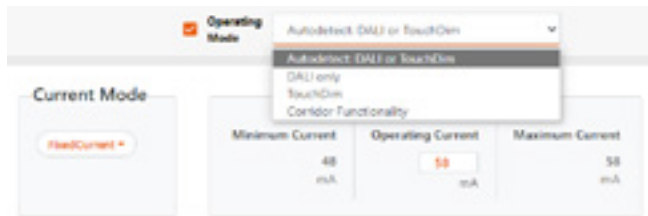

Notes:

Operating current:

With this parameter, the desired maximum light output is programmed. In the factory setting, this current is set to the rated light engine input current to achieve the rated light output of the light engine.

Maximum rated current:

The indicated maximum rated current is identical to the rated light engine input current.

Minimum rated current:

The indicated minimum current shows the lowest operating current which can be programmed so that the light engine can still achieve a light dimming level of 1% referred to the adjusted operating current.

Calculation for current vs. light output

To transfer your desired light engine luminous flux into the value which has to be inserted into the Tuner4TRONIC® input field, you can use the diagrams shown below.

T4T current set vs. light output for PL-FLAT-AC-DA-G3 1500

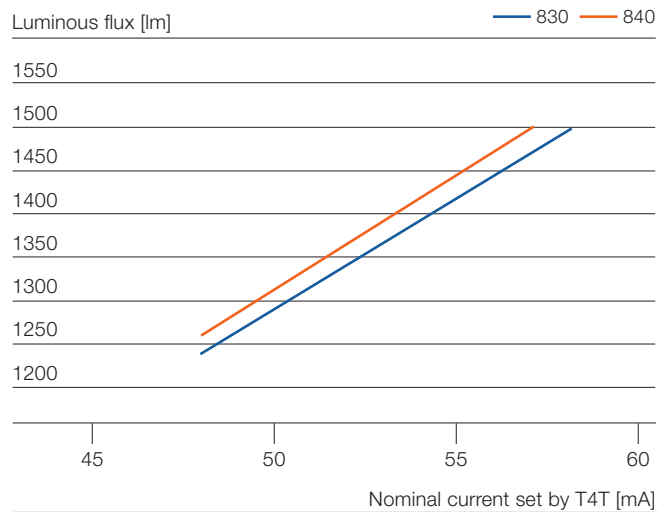

T4T current set vs. light output for PL-FLAT-AC-DA-G3 2500

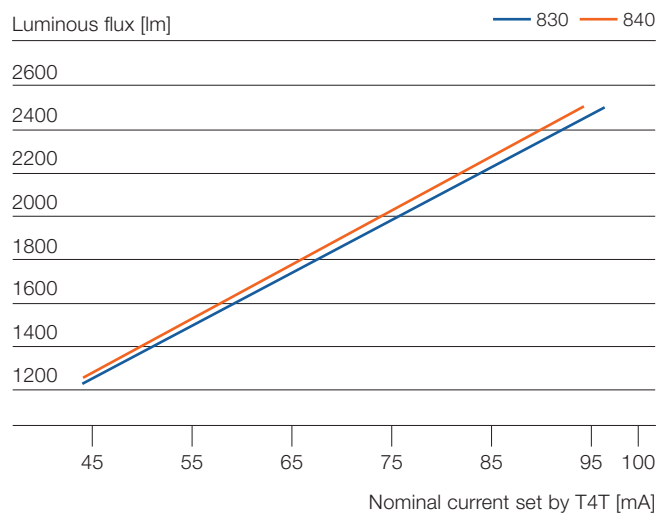

T4T current set vs. light output for PL-FLAT-AC-DA-G3 4000

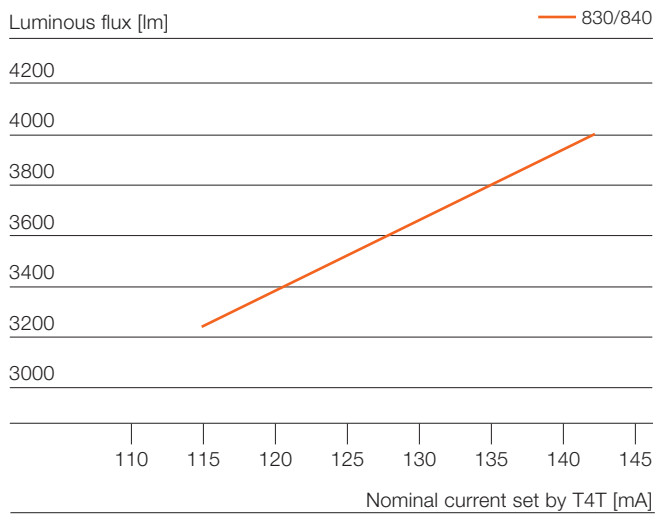

T4T current set vs. light output for PL-FLAT-AC-DA-G3 5000

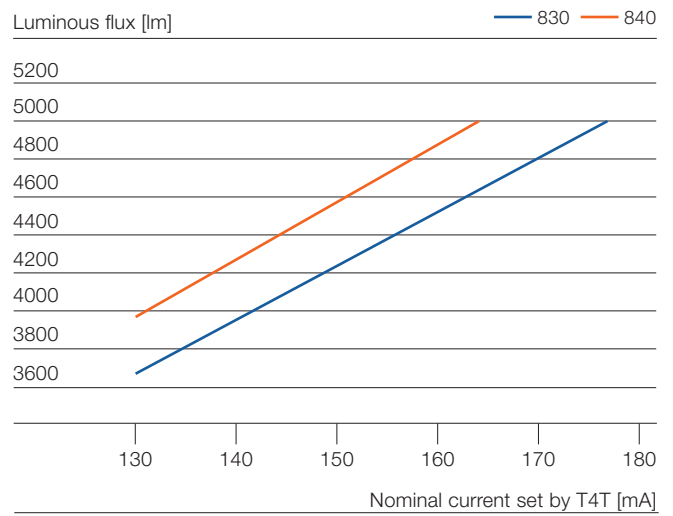

For further information regarding Tuner4TRONIC®, please see the Tuner4TRONIC® help file which you can find in the software itself.

12 Norms and standards

Safety:	IEC/EN 62031
Performance:	IEC 62717
Photobiological safety:	IEC/EN 62471 Risk group 1 (prior to mounting in a diffuse luminaire)
Electromagnetic compatibility:	EN 55015/CISPR15 IEC/EN 61000-3-2 IEC/EN 61000-3-3 IEC/EN 61547
Ingress protection:	Without touch protection: No ingress protection With touch protection: IP20
Approval:	CE, ENEC, UKCA



Disclaimer

All information contained in this document has been collected, analyzed and verified with great care by INVENTRONICS. However, INVENTRONICS is not responsible for the correctness and completeness of the information contained in this document and INVENTRONICS cannot be made liable for any damage that occurs in connection with the use of and/or reliance on the content of this document. The information contained in this document reflects the current state of knowledge on the date of issue.

Use our contact form

www.inventronics-light.com/contact-us



Service contact:

Inventronics GmbH

Parkring 31-33, 85748 Garching, Germany

www.inventronics-light.com

support@inventronicsglobal.com

INVENTRONICS is a licensee of ams
OSRAM. OSRAM is a trademark of ams
OSRAM.

inventronics