



Light is magnetic  
Impressive advertising  
and backlighting

Light is OSRAM

**OSRAM**

# Attracting attention, transforming environments: BackLED® and BoxLED® create highlights

In exterior as well as interior areas, impressive backlighting of surfaces is not only used in signage, but also, and increasingly, for the visual highlighting of buildings and products. In the development of corresponding light sources, the homogeneity of illumination, a uniform color effect and economic efficiency have top priority. With their brilliant light, the BackLED® and BoxLED® product families ensure impressive results as design elements, eye-catchers in advertising or for the accentuation of interiors.





# Amazingly versatile: Light systems from OSRAM

Perfect illumination for any shape

In backlighting, the flexible adaptation of LED modules to objects of various shapes, sizes and materials is a crucial factor. In order to make them perfectly adaptable to any given shape, the LEDs of the BackLED® and BoxLED® modules are placed on flexible chains at regular distances.

And because OSRAM offers a matching module for a broad range of transmissions or translucences, the material for backlighting, e.g. acrylic glass, foils or textiles, is of lesser importance and can be chosen freely.





#### City light posters

- Homogeneous backlighting
- High economic efficiency



#### Channel letters

- Homogeneous backlighting
- High recognition of the lettering
- High color rendering index (CRI)

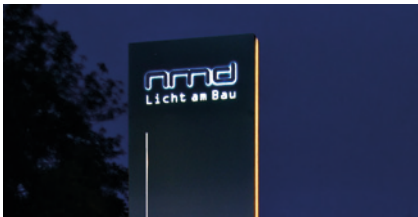

#### Single-sided or double-sided light boxes

- Homogeneous backlighting
- High efficiency when replacing T5 or T8 lamps by LED modules



Kempinski Hotel Corvinus Budapest/MKV Design LTD. UK

#### Indoor illuminated walls

- Long switch-on times (up to 24 hours per day)
- Long lifetime and reliable operation
- Dimming capability



#### Billboards

- Low maintenance for installations at great heights
- Long switch-on times (up to 24 hours per day)
- Long lifetime and reliable operation



#### Illuminated ceilings

- Decorative backlighting
- Change from warm white to cold white for daylight simulation
- Changing ambiances in conference rooms and shops



#### Custom luminaires

- Bespoke-shaped luminaires
- Dynamic white or color scenes
- Very uniform low and high luminance levels

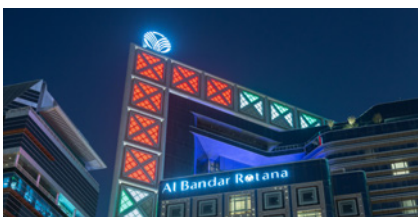

#### Special applications

- Dynamic colored backlit façades
- Resistance to high temperatures and damp conditions



# One-stop-shop components for full visual experiences

A highly functional system not only requires high-performance LED modules, but also perfectly matched LED drivers, hands-on mounting accessories and an intelligent light management. For all of the above, OSRAM offers a complete portfolio, including comprehensive services and guaranteeing.

## Complete systems from OSRAM: Perfection down to the smallest detail

As one of the world's leading light manufacturers, OSRAM can support you during the implementation of your project: from system planning and the selection of matching components to the comprehensive product guarantee.

### BackLED® AREA for backlighting of large areas with low return depth



Specifically designed for perfect light uniformity in large ceiling luminaires, stretch ceilings and large advertising boxes with extra-low depth

### BackLED® for direct backlighting

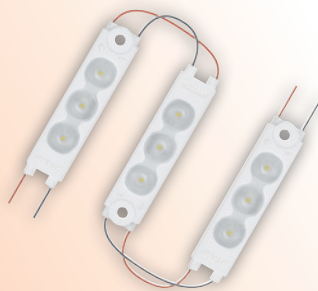

Ideally suited for backlighting of flat and slim installations

### Accessories Mounting profiles

Mounting profiles, matched to the individual modules for quick and easy installation: they save about 25% time in comparison to a screw connection of individual modules

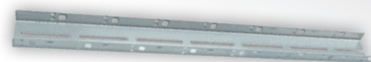

\* Details about our terms of guarantee can be found at [www.osram.com/guarantee](http://www.osram.com/guarantee)

### Light Management Systems (LMS)

Effective light management systems for “dynamic backlighting” and energy-saving installations: CASAMBI, DALI and 1-10 V via PWM

### OPTOTRONIC® LED drivers



Efficient constant-voltage LED drivers for 12-V and 24-V LED modules for indoor and outdoor areas

### Service LED deSIGNer

The online tool helps calculating the necessary amount of LED modules, LED drivers and mounting profiles

## High-Performance System

### Guarantee

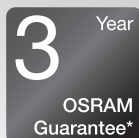

Comprehensive guaranteeing for best product quality and high-quality lighting systems

### BoxLED® for backlighting by side injection



Specially designed for light boxes of various dimensions, alternative to direct backlighting thanks to easier mounting with less modules

# Using optics for optimal light effects



Optics improve illumination and reduce the number of required LED modules

## Flat-Ray Technology from OSRAM is the key to optimized light distribution

Special optics allow for a homogeneous light distribution between individual LEDs even when the pitch between these LEDs is large. Overall, this means you need less LEDs for a perfect result. Moreover, thanks to the large beam angle of up to 160°, the distance between the LED module and the backlit surface can be reduced. This means even small and flat installations, e.g. channel letters, can be perfectly backlit.

## The new square lenses from OSRAM: More efficiency and reduced energy costs

With the patented square lenses from OSRAM, you can reach a higher level of efficiency. Due to their quadrant symmetric light distribution, square lenses can be placed optimally to achieve an uninterrupted illumination, avoiding the shadows that occur with round batwing lenses. This results in a reduced number of LED modules and a lower energy consumption.

## Homogeneous light distribution through Square-Lens Technology

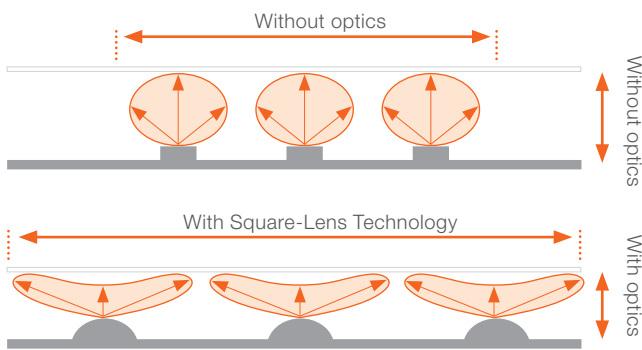

- Less modules (wider area coverage)
- Shallow light ceiling

## Oval-Lens Technology from OSRAM: specific for narrow applications

Modules equipped with Oval-Lens Technology allow uniform illumination in narrow channels, where round or square optics are too wide in both directions. Oval-Lens Technology focuses on optimising module arrays without opening the light beam too much where it's not needed.

## Batwing lenses with a beam angle of 155°

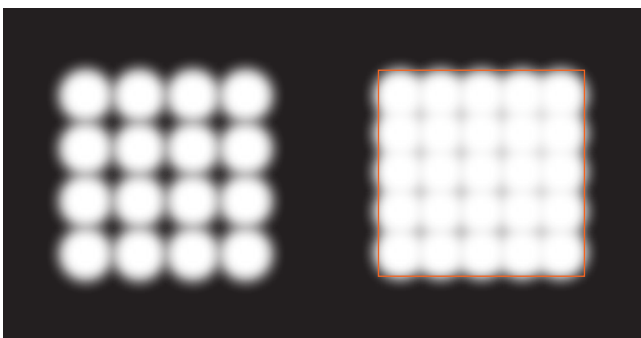

Formation of shadows with black holes

Homogeneous illumination by overlapping of the light-emitting surfaces with more modules

### Features:

- Rotational symmetric light distribution
- Batwing light distribution
- State of the art

## Square lenses with a beam angle of 155°



Homogeneous illumination of the entire light ceiling with fewer modules

### Features:

- Quadrant symmetric light distribution
- Square light distribution
- Innovative, patented lens technology from OSRAM

## Oval lenses with beam angle of 160 x 120°

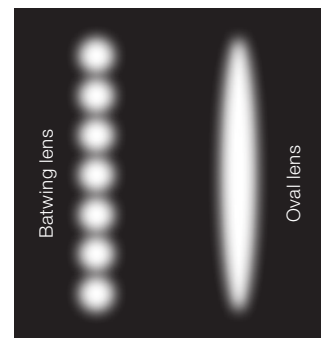

Homogeneous illumination through narrow module arrays

### Features:

- Designed for narrow backlit channels > 9mm
- Oval light distribution
- No light wasted on widths





# Mounting profiles for quick, easy and precise installation

Mounting provides the basis for the efficiency and economy of the entire system

Time and precision play an important role in light installations. Consequently, a quick mounting process, which is optimally supported by mounting profiles from OSRAM, is a proven means to reduce costs.

For installation, the LED modules are simply snapped into the profiles which are then bolted down with screws driven through pre-drilled mounting holes. Thanks to the regular distances between the drill holes in the mounting profiles,

the modules can be placed at even pitches without the need of measuring. Within the profiles, however, they can be moved back and forth flexibly, as required.

The even arrangement of the modules therefore ensures a homogeneous illumination of the entire surface. Moreover, thanks to the strong aluminum profiles, the entire construction is very robust and maintenance-friendly.

## Functions and dimensions of the mounting profiles

1) Side injection (single-sided and double-sided)

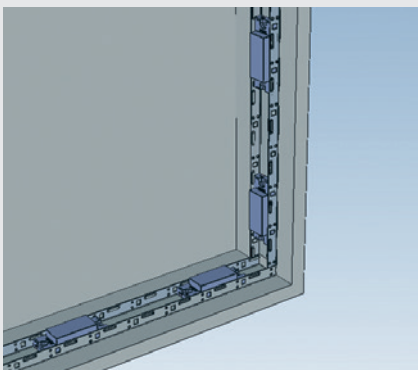

Along the inner sides of the edges with BoxLED® modules

### Mounting profile BX-MP

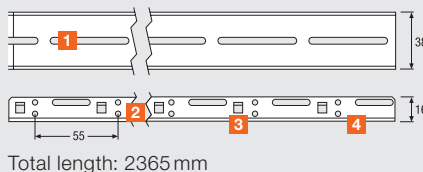

2) Backlighting (single-sided)

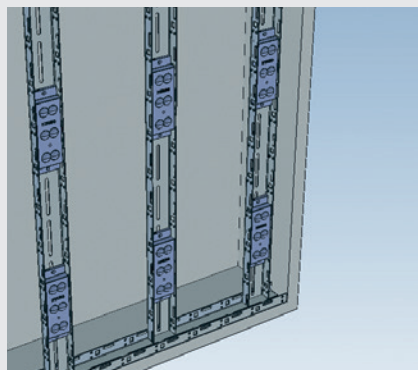

On the back wall of the light box with BackLED® modules

### Mounting profile BA-MP



### Mounting profile BA-SM-MP

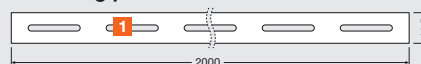

### Mounting profile BA-MP-M-CP

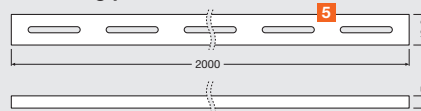

Total length: 2000 mm

3) Backlighting (double-sided)

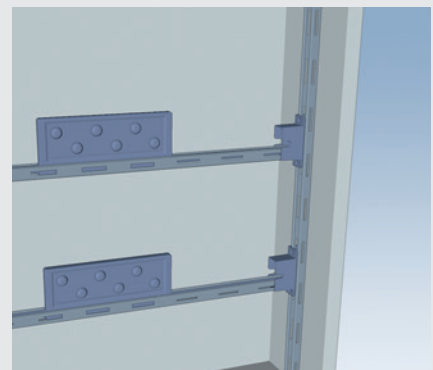

Special mounting profile with mounting brackets for BackLED® DS Plus

### Mounting system DS

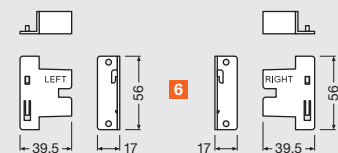
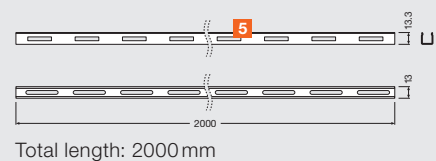

- 1 Slot holes for the mounting of the profile on the rear board or side board of the light box.
- 2 Holes for the easy installation of a mounting grid. The constant hole spacing of 55/50mm provides consistent pitches of LED modules without measuring.
- 3 Square holes for simple fixing of electrical cables with cable ties.
- 4 Embossings/edges for the easy click-in of the individual LED modules (Click & Play).
- 5 Holes for the easy installation of a mounting grid. The constant hole spacing of 50 mm provides consistent pitches of LED modules without measuring.
- 6 Mounting brackets for BackLED® DS Plus to connect the mounting profiles with the LED modules to the mounting profiles which are assembled on the side of the box.

All figures in mm

# The BackLED® product family takes on the challenge

The modules of the BackLED® family offer a broad range of various versions for direct backlighting to signage manufacturers, electricians, lighting planners and architects

BackLED® Plus modules are designed for single-sided backlighting in various dimensions, whereas BackLED® DS Plus modules are suitable for double-sided light injection. BackLED® TW Plus presents a dynamic and broad range of white light colors and the RGBW version is available for colorful light installations. Moreover, for special applications, BackLED® M Plus HO combine homogeneous light distribution with very high brightness.





See page  
12

BackLED® Mini S-M



See page  
12

BackLED® XS-XL



See page  
12

BackLED® M CP G4 A



See page  
12

BackLED® M HO CP G4



See page  
12

BackLED® L CX G4

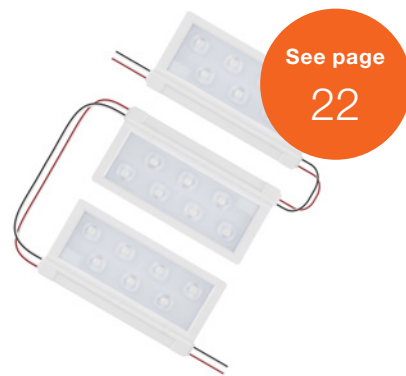

See page  
22

BackLED® DS Plus G3



See page  
24

BackLED® TW Plus G2



See page  
28

BackLED® RGBW Plus G2



See page  
34

BackLED® AREA

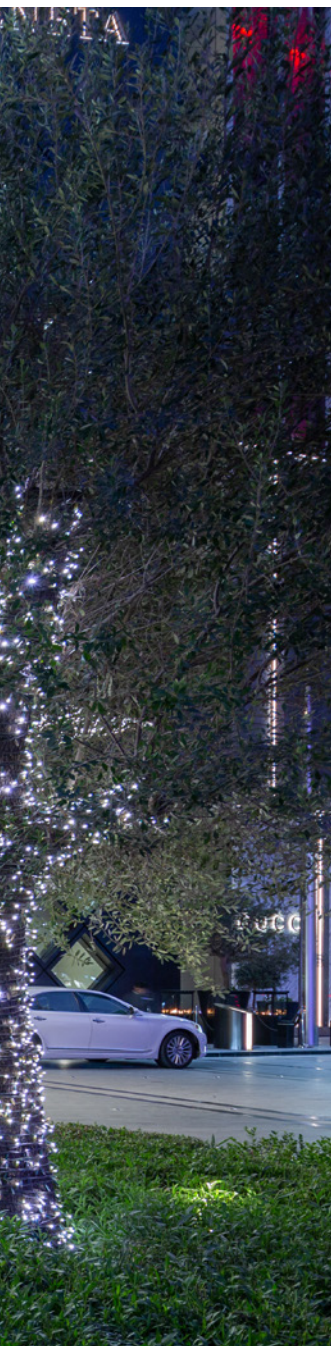

# BackLED® XS–XL Plus



## BackLED® Plus modules grow with their tasks – from XS to XL

The versions BackLED® XS, S, M, L and XL Plus have different dimensions and luminous fluxes. Depending on the size of the channel letters and light boxes, you can thus find the matching module for any requirement. All modules are equipped with optics that ensure homogeneous light distribution.

### BackLED® Plus application areas

- Channel letters
- Light boxes with high luminance requirements
- Decorative lighting
- Long-term outdoor application only in closed light boxes or channel letters

### Family features and benefits

- Lifetime of up to 50,000 h (L70B50) at  $T_p$
- Consistent white light (<3 SDCM)
- Uniform illumination thanks to specifically designed optics: Square-Lens, Flat-Ray, Elliptical-Lens Technologies

### Application areas

- Luminous ceilings/walls
- Decorative lighting
- Signage
- Channel letters
- Luminous boxes

### Standards

- CE, ENEC, UL-recognized component: Check valid approvals printed on products and labels





## Dimensions

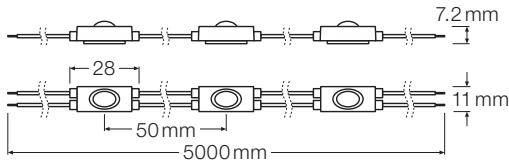

### BA-XS-CP G4

Number of LEDs per module = 1; number of modules per chain = 100

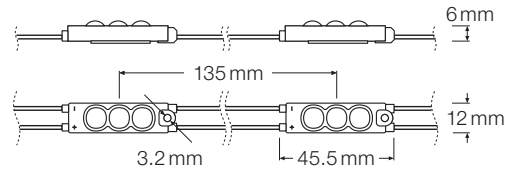

### BA-S-PL G15 BLUE - GREEN

Number of LEDs per module = 3; number of modules per chain = 45

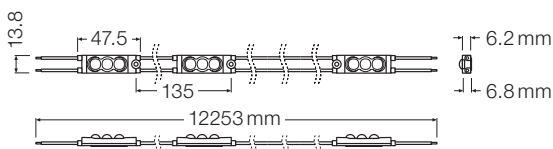

### BA-S-CP G4

Number of LEDs per module = 3; number of modules per chain = 90

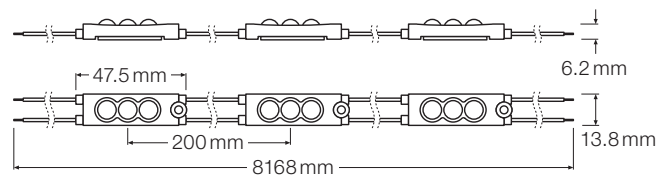

### BA-M-CP G4

Number of LEDs per module = 3; number of modules per chain = 40

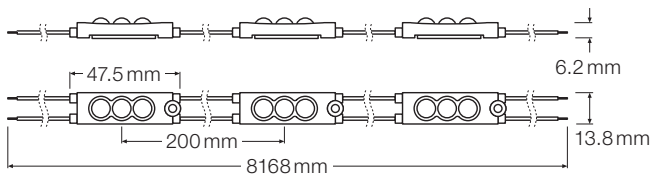

### BA-M-HO-CP G4

Number of LEDs per module = 3; number of modules per chain = 40

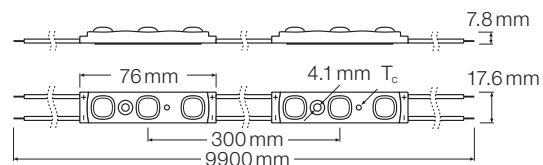

### BA-L-PL G3

Number of LEDs per module = 3; number of modules per chain = 36

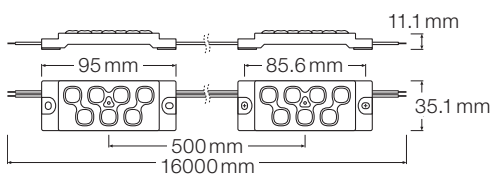

### BA-XL-PL G3

Number of LEDs per module = 7; number of modules per chain = 32

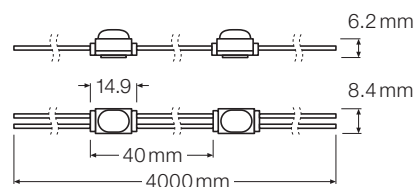

### BA-MINI-S-CP G4

Number of LEDs per module = 1; number of modules per chain = 100

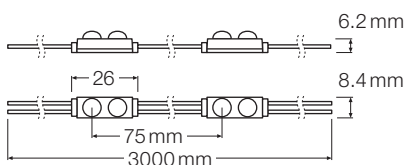

### BA-MINI-M-CP G4

Number of LEDs per module = 2; number of modules per chain = 40

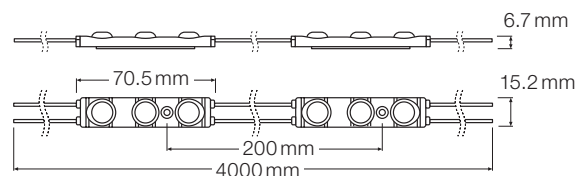

### BA-L-CX G4

Number of LEDs per module = 3; number of modules per chain = 20

## Electrical and output data

Nominal voltage	12 V (S-M/M HO-L); 24 V (XL)
Reverse voltage protection up to	13 V (S-M/ M HO-L); 25 V (XL)
Temperature range in operation at $T_c$ point	-30...+65 °C (S); -25...+75 °C (L-XL); -25...+60 (XS); -30...+70 (M G4/M HO G4); -25...+80 °C (MINI-S / MINI-M)
Storage temperature	-25...+85 °C

Light distribution diagrams

**BackLED® XS CP G4**

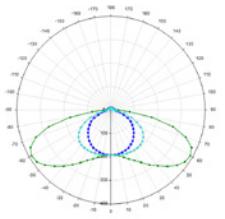

cd/1000lm

- C0-C180, 120.2°
- C90-C270, 158.4°
- C45-C225, 135.8°
- C135-C315, 135.8°

**BackLED® S-M CP G4**

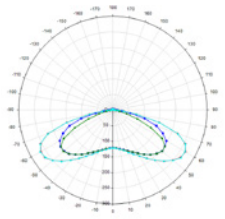

cd/1000lm

- C0-C180, 149.7°
- C90-C270, 144.0°
- C45-C225, 152.1°
- C135-C315, 152.1°

**BackLED® M HO CP G4**

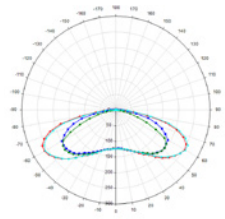

cd/1000lm

- C0-C180, 156°
- C90-C270, 140.0°
- C45-C225, 155°
- C135-C315, 155°

**BackLED® L CX G4**

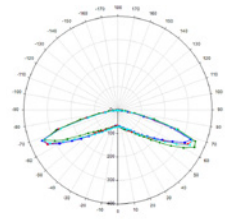

cd/1000lm

- C0-C180, 148°
- C90-C270, 152°
- C45-C225, 148°
- C135-C315, 148°

**BackLED® L PL G3**

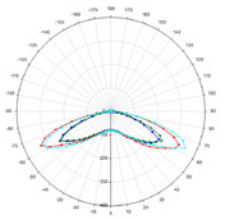

cd/1000lm

- C0-C180, 144°
- C90-C270, 144°
- C45-C225, 153°
- C135-C315, 153°

**BackLED® XL PL G3**

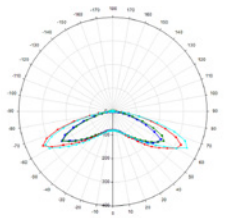

cd/1000lm

- C0-C180, 144°
- C90-C270, 144°
- C45-C225, 153°
- C135-C315, 153°

**BackLED® Mini S CP G4**

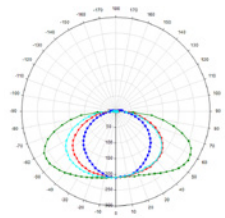

cd/1000lm

- C0-C180, 164°
- C90-C270, 144°
- C45-C225, 140°
- C135-C315, 152°

**BackLED® Mini M CP G4**

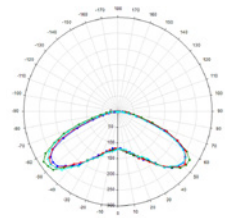





cd/1000lm

- C0-C180, 144°
- C90-C270, 144°
- C45-C225, 144°
- C135-C315, 144°



BackLED® Mini Slim lettering application

## BackLED® Plus



Modules	EAN	 COLOR	No. of modules		V	W <sup>1)</sup>		K	$\lambda$	lm <sup>1)</sup>	IP	
<b>BackLED® XS CP G4</b>												
BA-XS-CP 880	4052899593145	white	100	1	12	30 (0.3)	160x120 <sup>3)</sup>	8000	-	2850 (28.5)	IP66	50
BA-XS-CP 865	4052899593176	white	100	1	12	30 (0.3)	160x120 <sup>3)</sup>	6500	-	2850 (28.5)	IP66	50
<b>BackLED® S CP G4</b>												
BA-S-PL 865	4062172166553	white	90	3	12	28.8 (0.32)	155 <sup>2)</sup>	6500	-	3510 (39)	IP66	25
BA-S-PL 840	4062172166577	white	90	3	12	28.8 (0.32)	155 <sup>2)</sup>	4000	-	3510 (39)	IP66	25
BA-S-PL 830	4062172166591	white	90	3	12	28.8 (0.32)	155 <sup>2)</sup>	3000	-	3420 (38)	IP66	25
BA-S-CP RED	4062172166614	red	90	3	12	31.5 (0.35)	155 <sup>2)</sup>		625	1305 (14.5)	IP66	25
<b>BackLED® S Plus G15</b>												
BA-S-PL BL	4052899300675	blue	45	3	12	16.9 (0.38)	155 <sup>2)</sup>		466	255 (5.7)	IP66	5
BA-S-PL GN	4052899300651	green	45	3	12	16.9 (0.38)	155 <sup>2)</sup>		523	1110 (24.7)	IP66	5
<b>BackLED® M CP G4</b>												
BA-M-CP 880	4062172183277	white	40	3	12	28.8 (0.72)	155 <sup>2)</sup>	8000	-	3160 (79)	IP66	50
BA-M-CP 865	4062172183352	white	40	3	12	28.8 (0.72)	155 <sup>2)</sup>	6500	-	3160 (79)	IP66	50
BA-M-CP 840	4062172183376	white	40	3	12	28.8 (0.72)	155 <sup>2)</sup>	4000	-	3160 (79)	IP66	50
BA-M-CP 830	4062172183390	white	40	3	12	28.8 (0.72)	155 <sup>2)</sup>	3000	-	3000 (75)	IP66	50
<b>BackLED M CP G4 Advanced</b>												
BA-M-CP-865 A	4062172183680	white	40	3	12	28.8 (0.72)	155 <sup>2)</sup>	6500	-	3160 (79)	IP66	50
<b>BackLED® M CP COL G4</b>												
BA-M-CP-RED	4062172183413	red	40	3	12	24 (0.60)	155 <sup>2)</sup>		625	840 (21)	IP66	50
BA-M-CP-BLUE	4062172183437	blue	40	3	12	24 (0.60)	155 <sup>2)</sup>		470	360 (9)	IP66	50
<b>BackLED® M HO CP G4</b>												
BA-M-HO-CP 880	4062172183512	white	40	3	12	48 (1.2)	150	8000	-	4880 (122)	IP66	50
BA-M-HO-CP 865	4062172183499	white	40	3	12	48 (1.2)	150	6500	-	5240 (131)	IP66	50
BA-M-HO-CP 840	4062172183475	white	40	3	12	48 (1.2)	150	4000	-	5240 (131)	IP66	50
BA-M-HO-CP 830	4062172183451	white	40	3	12	48 (1.2)	150	3000	-	4880 (122)	IP66	50
<b>BackLED® L Plus G3</b>												
BA-L-PL 865	4052899990425	white	36	3	12	47 (1.3)	155 <sup>2)</sup>	6500	-	5400 (150)	IP66&IP68	5
BA-L-PL 840	4052899990449	white	36	3	12	47 (1.3)	155 <sup>2)</sup>	4000	-	5580 (155)	IP66&IP68	5
BA-L-PL 830	4052899990463	white	36	3	12	47 (1.3)	155 <sup>2)</sup>	3000	-	5400 (150)	IP66&IP68	5

1) Chain (module)

2) Square lens

3) Elliptical lens

## BackLED® Plus

Modules	EAN	COLOR	No. of modules		V	W <sup>1)</sup>		K	$\lambda$	lm <sup>1)</sup>	IP	
<b>BackLED® XL Plus G3</b>												
BA-XL-PL 865	4052899990487	white	32	7	24	71 (2.2)	155 <sup>2)</sup>	6500	-	9600 (300)	IP66&IP68	5
BA-XL-PL 840	4052899990500	white	32	7	24	71 (2.2)	155 <sup>2)</sup>	4000	-	9760 (305)	IP66&IP68	5
BA-XL-PL 830	4052899990524	white	32	7	24	71 (2.2)	155 <sup>2)</sup>	3000	-	9600 (300)	IP66&IP68	5
<b>BackLED® Mini S CP G4</b>												
BA-MINI-S-CP-810-G4	4062172145909	white	100	1	12	36 (0.36)	160x120 <sup>3)</sup>	10000	-	3600 (36)	IP66	40
BA-MINI-S-CP-871-G4	4062172145886	white	100	1	12	36 (0.36)	160x120 <sup>3)</sup>	7100	-	3900 (39)	IP66	40
BA-MINI-S-CP-865-G4	4062172145862	white	100	1	12	36 (0.36)	160x120 <sup>3)</sup>	6500	-	3900 (39)	IP66	40
BA-MINI-S-CP-840-G4	4062172145848	white	100	1	12	36 (0.36)	160x120 <sup>3)</sup>	4000	-	3900 (39)	IP66	40
BA-MINI-S-CP-830-G4	4062172145824	white	100	1	12	36 (0.36)	160x120 <sup>3)</sup>	3000	-	3600 (36)	IP66	40
<b>BackLED® Mini M CP G4</b>												
BA-MINI-M-CP-810-G4	4062172145800	white	40	2	12	28.8 (0.72)	140	10000	-	2880 (72)	IP66	40
BA-MINI-M-CP-871-G4	4062172145787	white	40	2	12	28.8 (0.72)	140	7100	-	3160 (79)	IP66	40
BA-MINI-M-CP-865-G4	4062172145763	white	40	2	12	28.8 (0.72)	140	6500	-	3160 (79)	IP66	40
BA-MINI-M-CP-840-G4	4062172145718	white	40	2	12	28.8 (0.72)	140	4000	-	3160 (79)	IP66	40
BA-MINI-M-CP-830-G4	4062172145695	white	40	2	12	28.8 (0.72)	140	3000	-	2880 (72)	IP66	40
<b>BackLED® L CX G4</b>												
BA-L-CX-810-G4	4062172145671	white	20	3	12	30 (1.5)	160	10000	-	3000 (150)	IP66	30
BA-L-CX-871-G4	4062172145657	white	20	3	12	30 (1.5)	160	7100	-	3240 (162)	IP66	30
BA-L-CX-865-G4	4062172145633	white	20	3	12	30 (1.5)	160	6500	-	3240 (162)	IP66	30
BA-L-CX-840-G4	4062172145619	white	20	3	12	30 (1.5)	160	4000	-	3240 (162)	IP66	30
BA-L-CX-830-G4	4062172145596	white	20	3	12	30 (1.5)	160	3000	-	3000 (150)	IP66	30

1) Chain (module) 2) Square lens 3) Elliptical lens

## How to design a backlit area<sup>1</sup>

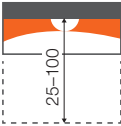
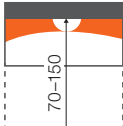
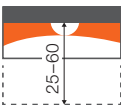
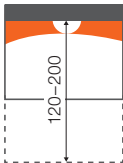
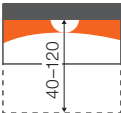
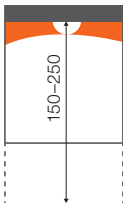
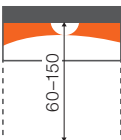
Depth of the box	Choose the right module	Depth of the box	Choose the right module
 25–100 mm	BA-Mini-S-CP BA-Mini-M-CP	 70–150 mm	BA-M-HO-CP G4 BA-L-CX G4
 25–60 mm	BA-XS-CP-G4	 120–200 mm	BA-L-PL G3
 40–120 mm	BA-S-PL-G15 COL and BA-S-CP G4	 150–250 mm	BA-XL-PL G3 (high luminous flux application)
 60–150 mm	BA-M-PL G4		

<sup>1</sup> The specified installation depths are only approximate values; the LED deSIGNer web tool provides detailed information



Module solution	Max. module pitch [mm]	Recommendations*		
		Installation depth [mm]	Suggested depth/pitch ratio	Type of lens
BackLED Mini S	40	25 / 100	1/1.5	○
BackLED Mini M	60	25 / 100	1/1.5	●
BackLED XS Plus G4	50	25 / 60	1 / 1.5	○
BackLED S Plus G4 / G15 COL	135	40 / 120	1 / 2	■
BackLED M Plus G4	200	60 / 120	1 / 2	■
BackLED M-HO G4	200	70 / 150	1 / 2	■
BackLED L CX G4	200	70 / 150	1/1.5	●
BackLED L Plus G3	200	120 / 180	1 / 3	■
BackLED XL Plus G3	500	150 / 200	1 / 3	■
BackLED DS Plus G3	400	100 / 150**	1 / 3**	■
BackLED TW Plus G2	400	150 / 200	1 / 2	●
BackLED RGBW Plus G2	400	150 / 200	1 / 2	●
BackLED AREA	n.a.	40 / 150	n.a.	x

\* Assumptions based on generic 50% transmittance frosted white acrylic. Depth and pitch vary according to diffusive material properties

\*\* On each emitting side

■ Square lens ● Flat-Ray ○ Oval lens x No lens

### How to specify a luminous ceiling

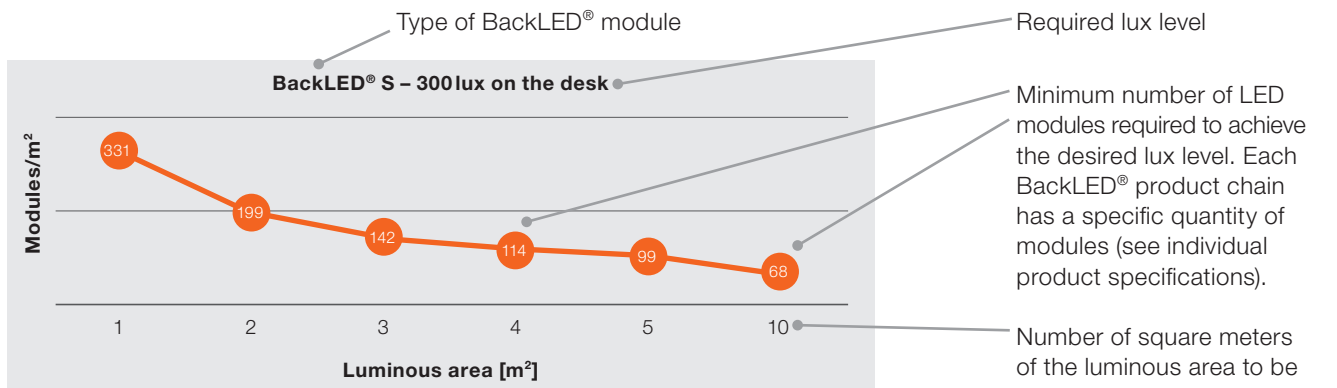

How to read the graph: Example (no planning values)

#### Note:

The bigger the area to be illuminated, the less LED modules per square meter are required to obtain the desired lux level. Uniformity must be considered regardless of the lighting level. Calculations based on a standard room, 3m high, with non-reflective walls. The reference stretch material has a transmission of 50%.

**Application guide BackLED® S G4**

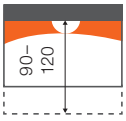

Use the BackLED® S when the depth of the luminous ceiling is around 90–120 mm.



How to get 300 lux on the desk level

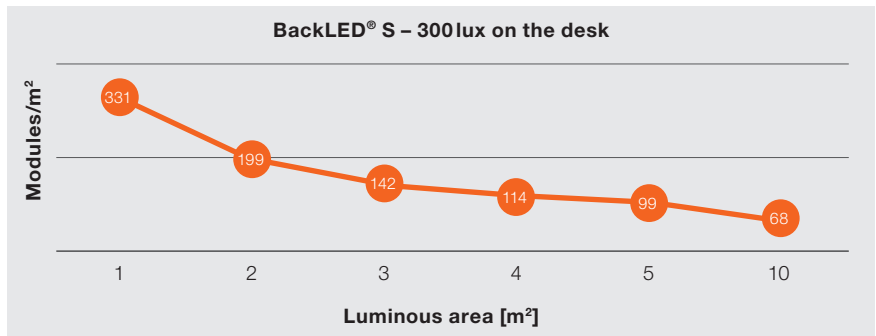
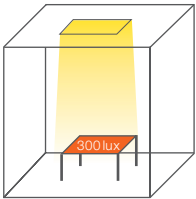

How to get 300 lux on the floor level

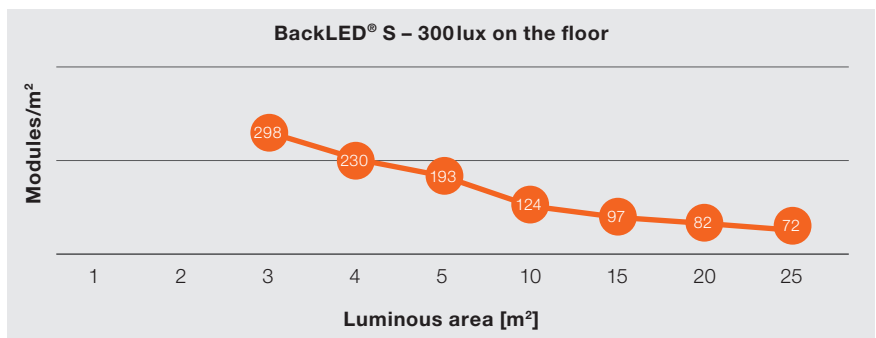
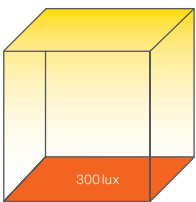

How to get 500 lux on the desk level

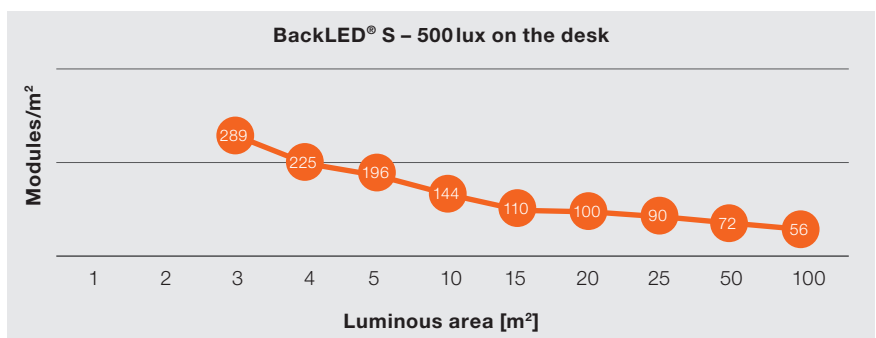
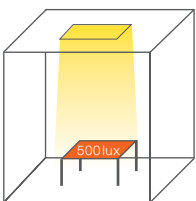

How to get 500 lux on the floor level

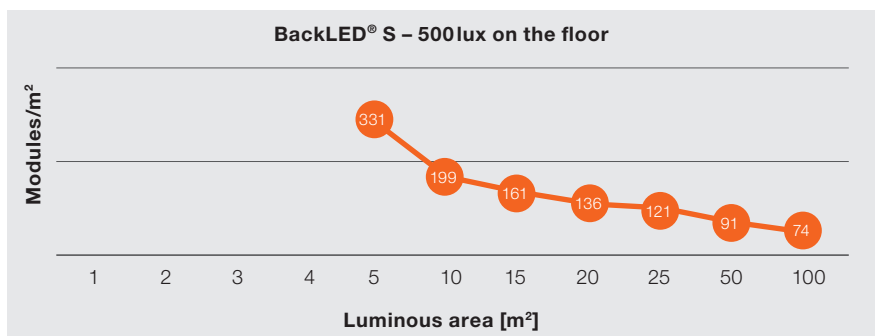
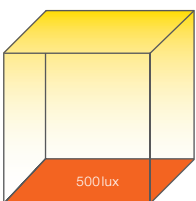

**Application guide BackLED® M HO CP G4**

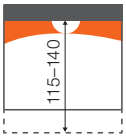

Use the BackLED® M HO when the depth of the luminous ceiling is around 115–140mm.



How to get 300lux on the desk level

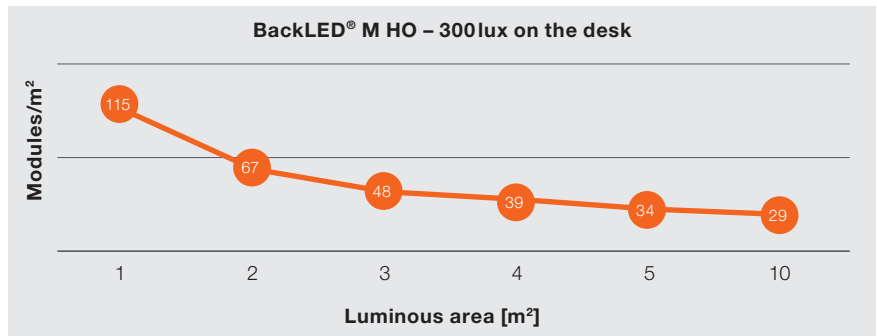
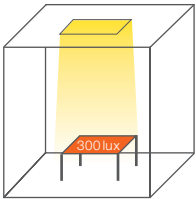

How to get 300lux on the floor level

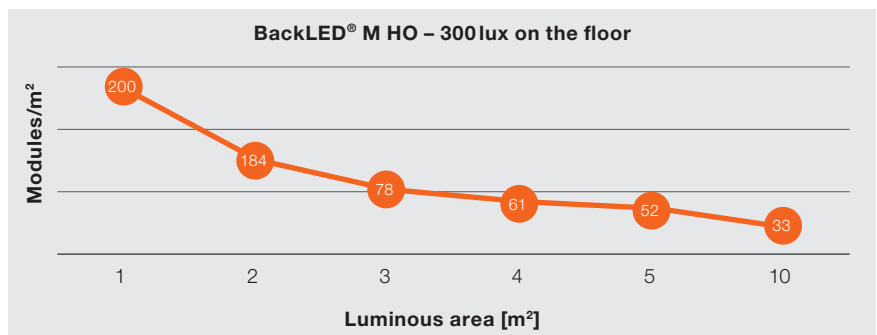
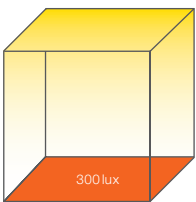

How to get 500lux on the desk level

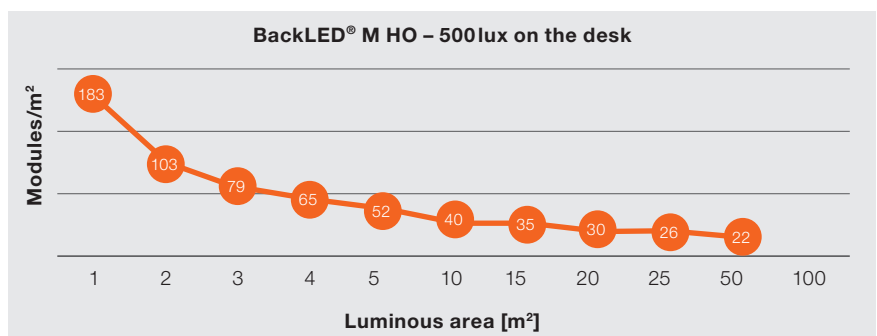
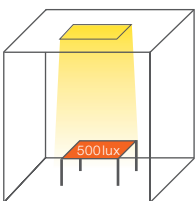

How to get 500lux on the floor level

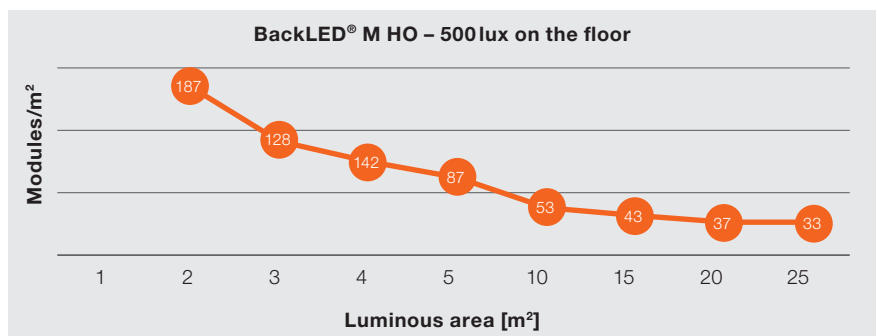
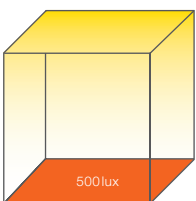

**Application guide BackLED® L G3**

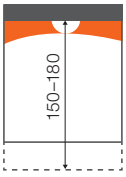

Use the BackLED® L when the depth of the luminous ceiling is around 150–180 mm.



© 2017 Barrisolo® Normalu®  
SAS - Arch.: Jean-François Brodbeck - AMRS Architectes

How to get 300 lux on the desk level

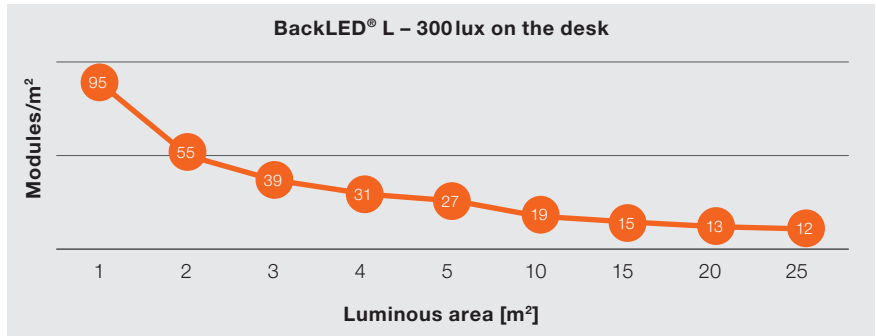
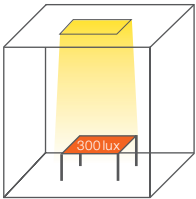

How to get 300 lux on the floor level

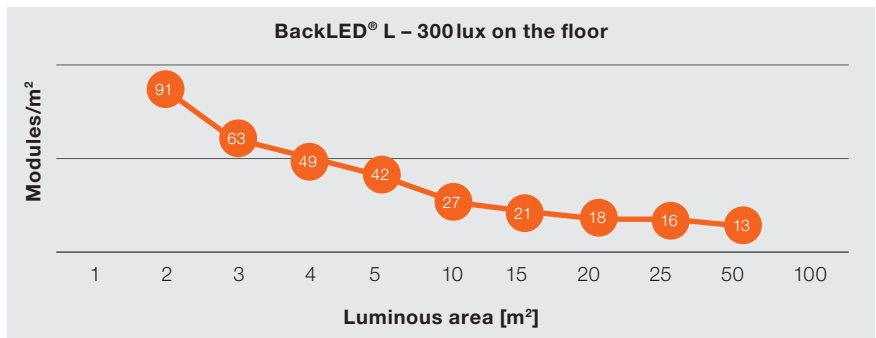
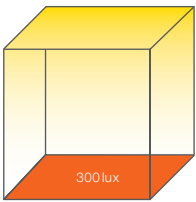

How to get 500 lux on the desk level

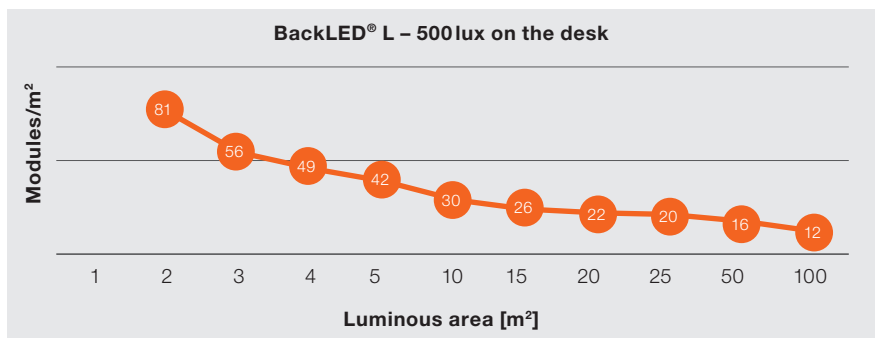
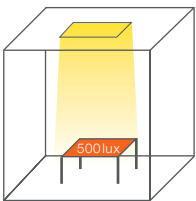

How to get 500 lux on the floor level

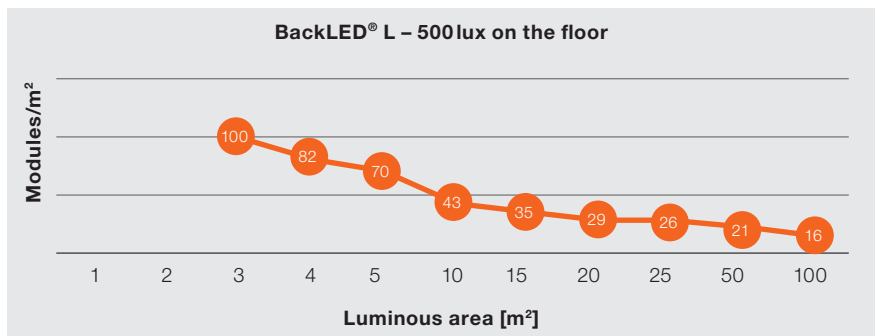
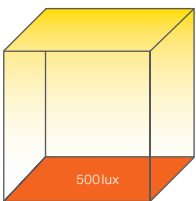

**Application guide BackLED® XL G3**

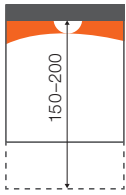

Use the BackLED® XL when a high luminous flux is needed and when the depth of the luminous ceiling is around 150–200 mm.

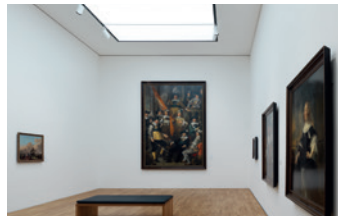

How to get 300 lux on the desk level

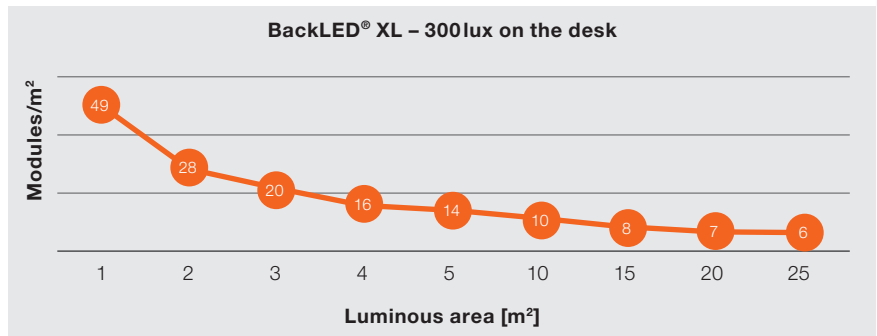
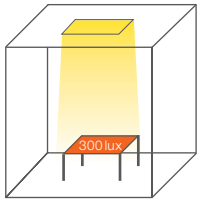

How to get 300 lux on the floor level

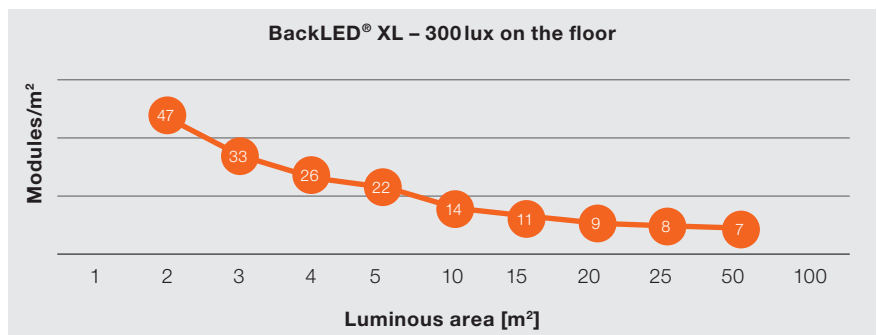
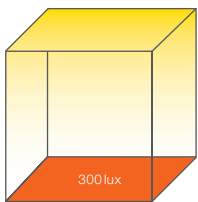

How to get 500 lux on the desk level

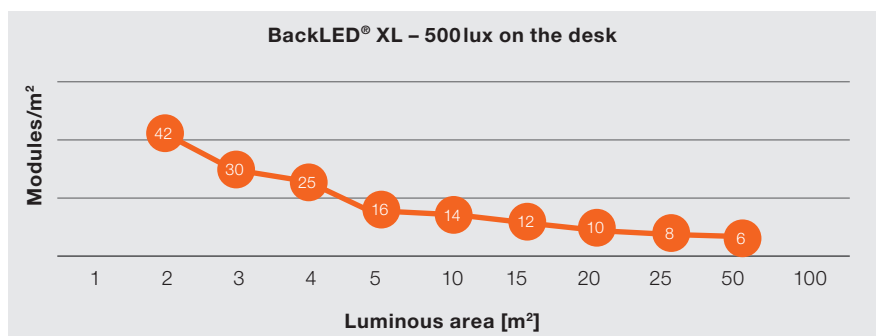
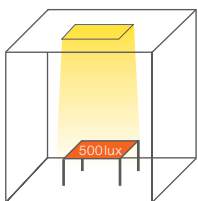

How to get 500 lux on the floor level

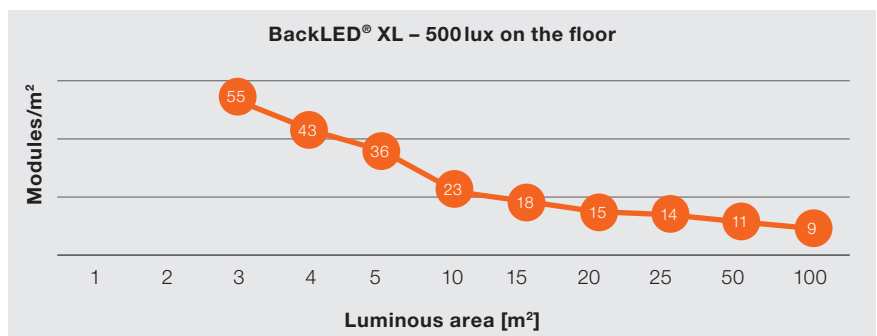
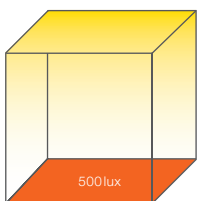

# BackLED® DS Plus G3



## **BackLED® DS Plus: Perfect light on both sides**

The unique design of BackLED® DS Plus modules for backlighting double-sided light boxes is now equipped with Square-Lens Technology and allows a thinner box design.

### **Application areas**

- Backlighting of double-sided light boxes and pylons
- Long-term outdoor application only in closed light boxes or channel letters

### **Features and benefits**

- Quick and easy mounting with screws or by snap-in into mounting profiles
- Homogeneous illumination thanks to Square-Lens Technology, now with greater distances between LED modules
- Overmoulded housing providing IP66 protection
- Outstanding module efficiency
- Very long lifetime
- High color rendering index (CRI >80)

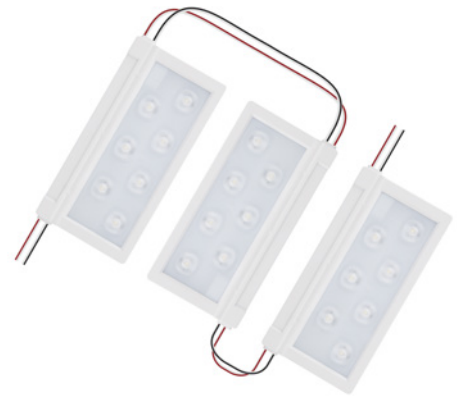



### Dimensions

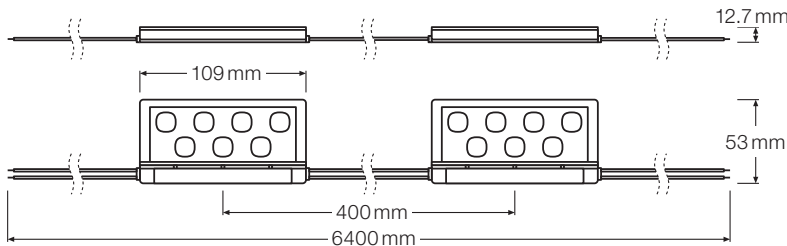

Number of LEDs per module = 7; number of modules per chain = 16

### Electrical and output data

Nominal voltage	24 V
Reverse voltage protection up to	25 V
Temperature range in operation at T <sub>c</sub> point	-25...+75 °C
Storage temperature	-25...+85 °C

BA-DS-PL 865	
Power per chain (module) [W]	71 (4.4) W
Luminous efficacy [lm/W]	136 lm/W
Luminous flux per chain (module) [lm]	9600 (600)
Color temperature	6500 K
CRI	> 80

### Light distribution diagram

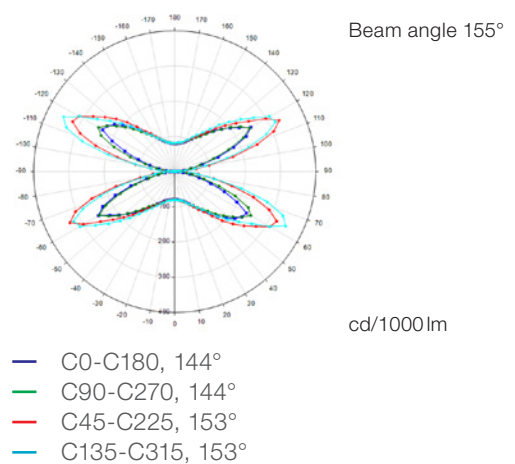

### BackLED® Plus

Modules	EAN	COLOR	No. of modules		V	W <sup>1)</sup>		K	λ	lm <sup>1)</sup>	IP	
<b>BackLED® DS Plus G3</b>												
BA-DS-PL 865	405289990548	white	16	14	24	71 (4.4)	155 <sup>2)</sup>	6500	-	9600 (600)	IP66	5

### How to build a double-sided box – suggested depths

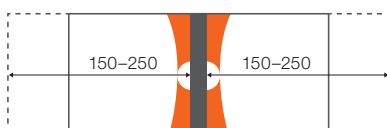

<sup>1</sup> The specified installation depths are only approximate values; the LED deSIGNer web tool provides detailed information

# BackLED® Tunable White



## BackLED® TW Plus for different hues of white

Some applications require illumination with different hues of white. Due to their range from warm white to cool white, BackLED® TW Plus modules are ideally suited to give rooms the right ambience, just as required.

### Application areas

- Illuminated ceilings
- Decorative accent lighting
- Facade backlighting

### Features and benefits

- Lifetime of up to 50,000h (L70B50) at  $T_p$
- Consistent white light (<3 SDCM)
- Dynamic light color: 2,700...6,500 K
- Fully potted module housing providing IP66 and IP68 protection
- Flexible programmable lighting moods in connection with light management systems
- UV- and IR-free to preserve exhibits
- Dimming range: 5...100 %

### Application areas

- Daylight simulation
- Luminous ceilings/walls in spas
- Shops
- Offices
- Museums
- Art galleries

### Standards

- CE + BIS





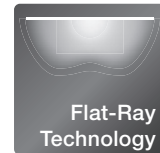

### Dimensions

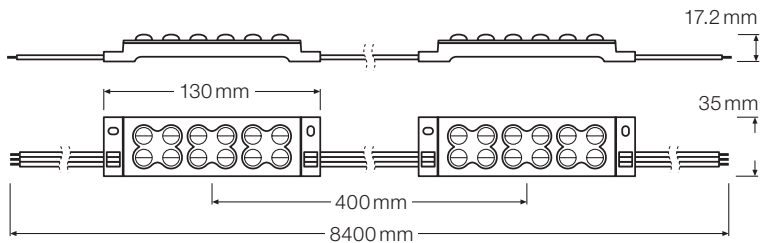

Number of LEDs per module = 12; number of modules per chain = 20

### Electrical and output data

Nominal voltage	24 V
Reverse voltage protection up to	24 V
Temperature range in operation at T <sub>c</sub> point	-25...+55 °C
Storage temperature	-25...+85 °C
Power per chain (module) [W]	96 (4.8)
Luminous efficacy [lm/W]	95.8
Luminous flux per chain (module) [lm]	9200 (460)
Color temperature	2700-6500 K
CRI	> 80

### Light distribution diagram

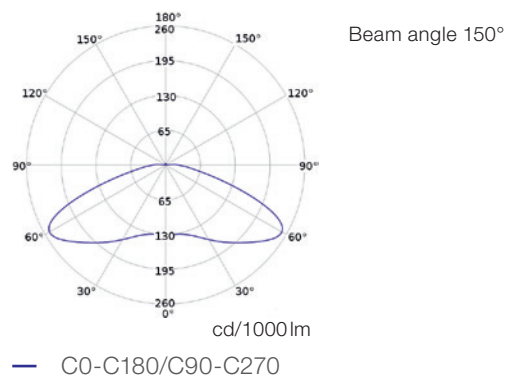

### BackLED® TW Plus G2

Modules	EAN	COLOR	No. of modules	V	W <sup>1)</sup>	K	Im <sup>1)</sup>	IP	5		
BackLED® TW Plus G2	BA-TW-PL 827-865 4052899452954	white	20	12	24	96 (4.8)	150	2700...6500	9200 (460)	IP66&IP68	5

1) Chain (module)

### How to specify a luminous ceiling

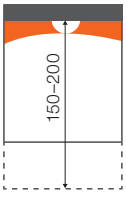

150–200 mm

### How many BackLED® modules are needed?

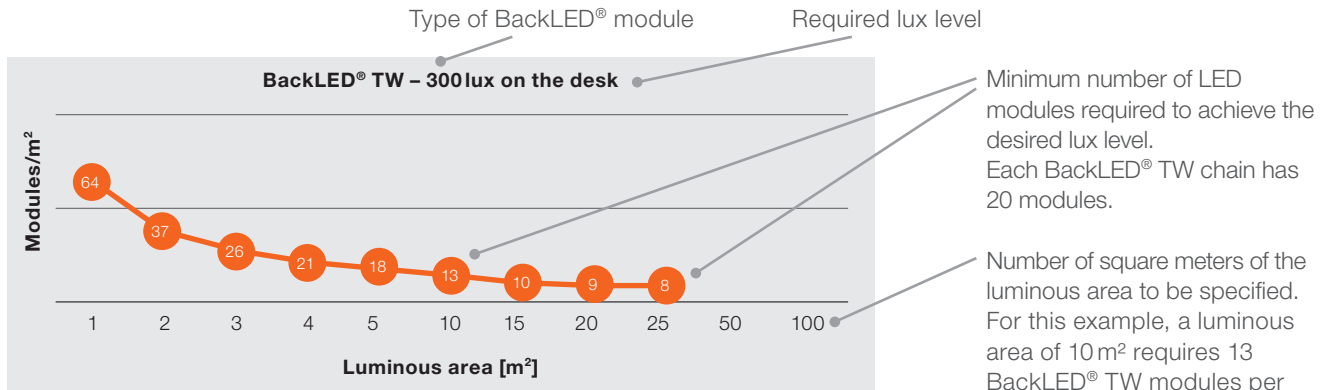

How to read the graph: Example (no planning values)

Minimum number of LED modules required to achieve the desired lux level. Each BackLED® TW chain has 20 modules.

Number of square meters of the luminous area to be specified. For this example, a luminous area of 10 m² requires 13 BackLED® TW modules per square meter (130 modules = 7 chains).

#### Note:

The bigger the area to be illuminated, the less LED modules per square meter are required to obtain the desired lux level. Uniformity must be considered regardless of the lighting level. Calculations based on a standard room, 3 m high, with non-reflective walls. The reference stretch material has a transmission of 50 %.

**Application guide BackLED® TW**

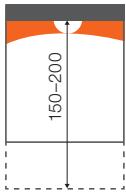

Use the BackLED® TW to achieve a dynamic lighting effect when the depth of the luminous ceiling is around 150–200 mm.



How to get 300 lux on the desk level

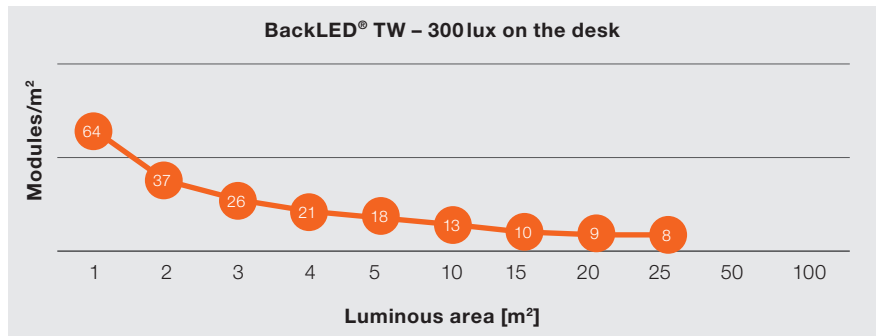
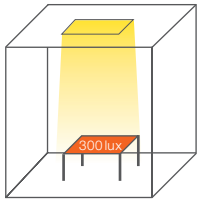

How to get 300 lux on the floor level

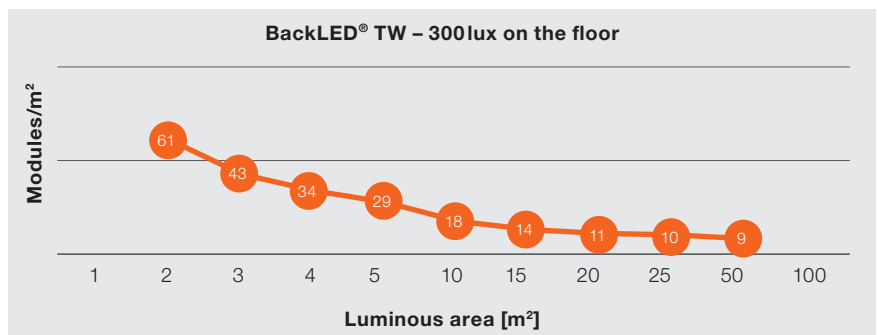
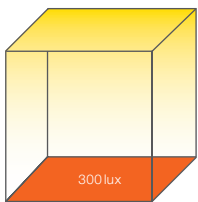

How to get 500 lux on the desk level

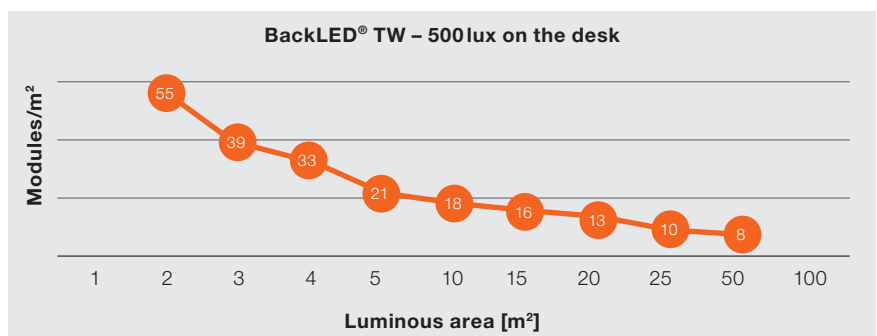
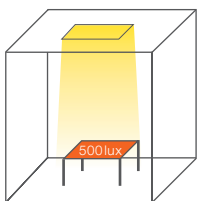

How to get 500 lux on the floor level

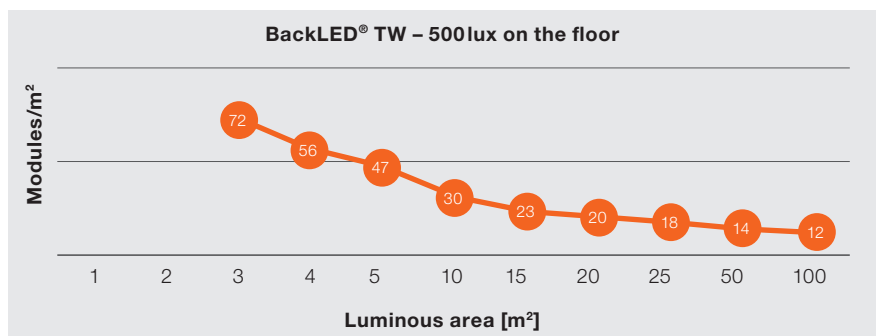
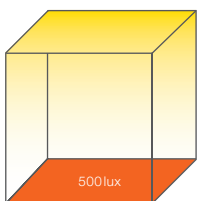

# BackLED® RGBW



## BackLED® RGBW Plus: Impressive presentation with changing colors

Through the application of BackLED® RGBW Plus modules, backlit surfaces can be presented appealingly with changing colors. These modules impress especially due to their uniform color effect, even when large surfaces are involved.

### Application areas

- Dynamic color backlighting
- Dynamic mood lighting
- Shop, restaurants
- Gyms, halls
- Facades and multi purpose rooms

### Features and benefits

- Lifetime of up to 50,000h (L70B50) at  $T_p$
- Broad color mixing palette in connection with light management systems
- Uniform backlighting surfaces thanks to extremely wide angle optics
- Dimmable by PWM
- Fully potted module housing providing IP66 and IP68 protection
- Compatible with mounting profile BX-MP

### Application areas

- Decorative backlighting
- Architecture lighting
- Facade backlighting

### Standards

- CE + BIS





### Dimensions

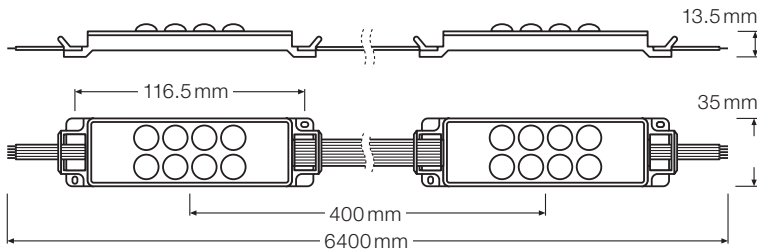

Number of LEDs per module = 8; number of modules per chain = 15; minimum Usable chain = 3 modules (and multiples of 3)

### Electrical and output data

Nominal voltage	24 V
Reverse voltage protection up to	24 V
Temperature range in operation at T <sub>c</sub> point	-25...+75 °C
Storage temperature	-25...+65 °C
Power per chain (module) [W]	42.6 (2.84)
Luminous efficacy [lm/W]	54 (all channels ON)
Luminous flux per chain (module) [lm]	2310 (154)
Color temperature (white)	6500K
CRI (white)	> 80
<b>Color</b>	<b>Dom. λ (nm) Current (mA)*</b>
● R	620 90
● G	525 130
● B	464 75
○ White	6500K 60

\* Values referring to minimum usable chain of 3 modules

### Light distribution diagram

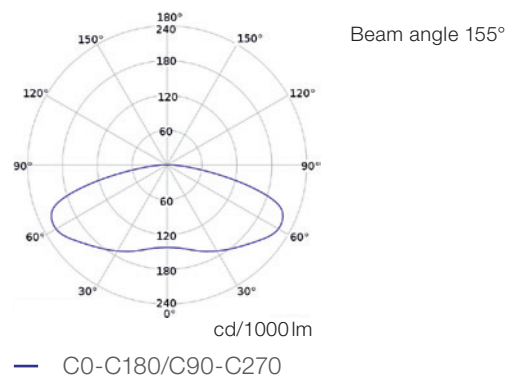

### BackLED® RGBW Plus G2

Modules	EAN	COLOR	No. of modules	⊙	V	W <sup>1)</sup>	△	K	λ	lm <sup>1)</sup>	IP	📦
BackLED® RGBW Plus G2												
BA-RGBW-PL	4052899452930	RGBW	15	8	24	42.6 (2.84)	155	620 nm 525 nm 464 nm 6500 K	-	2310 (154)	IP66&IP68	5

1) Chain (module)

## How to specify a luminous ceiling

### Minimum depth of the luminous ceiling with BackLED® RGBW

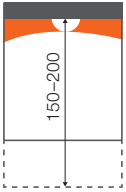

150–200 mm

Use the BackLED® RGBW when the depth of the luminous ceiling is around 150–200 mm.

### How many BackLED® modules are needed?

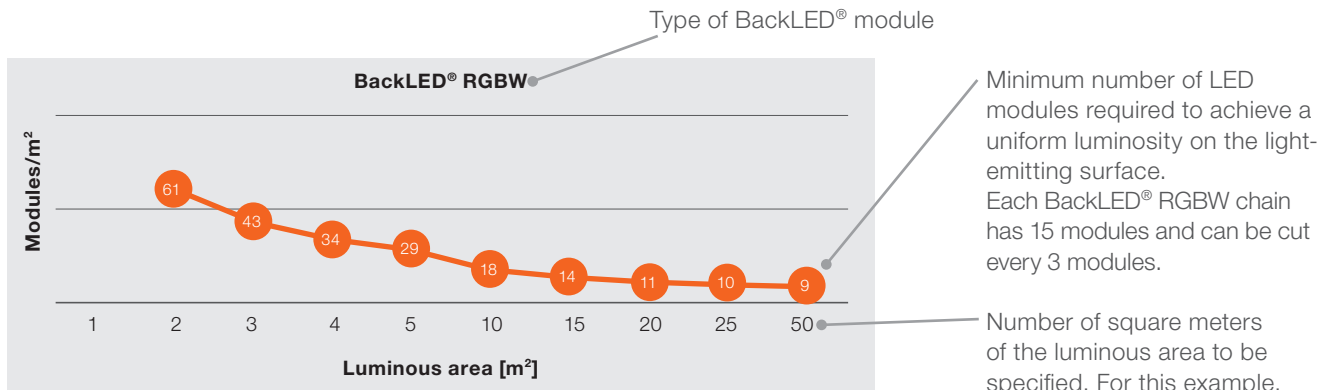

#### Note:

The bigger the area to be illuminated, the less LED modules per square meter are required. Uniformity must be considered regardless of the lighting level. Calculations based on a standard room, 3 m high, with non-reflective walls. The reference stretch material has a transmission of 50%.



**Matrix: Combination of accessories and LED modules**

Accessories EAN	BX-MP 4008321981110	BA-MP 4052899145863	BA-SM-MP 4052899264540	BA-MP-M-CP 4062172168410	BX-DS-MP 4008321880307	BX-DS-MB 4008321872173
Packaging unit	24	24	24	50	24	30 (15 left/15 right)
BackLED S CP G4				■		
BackLED S Plus G15			■			
BackLED M CP G4				■		
BackLED M HO CP G4				■		
BackLED L Plus G3		■				
BackLED XL Plus G3	■					
BackLED DS Plus G3					■	■
BackLED TW Plus G2	■					
BackLED RGBW Plus G2	■					
BoxLED XS Plus G3		■				
BoxLED ECO M Plus G3	■					
BoxLED M Plus G3	■					
BoxLED L Plus G15/G3	■					
BoxLED Indoor L Plus G1	■					

**Mounting profile BX-MP**

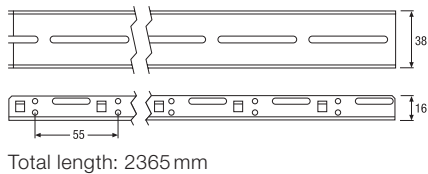

**Mounting profile BA-MP**

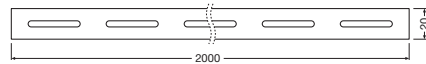

**Mounting profile BA-SM-MP**

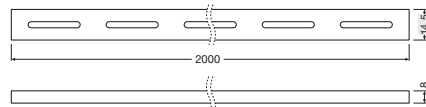

**Mounting profile BA-MP-M-CP**

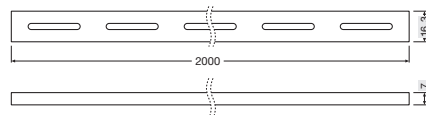

Total length: 2000mm

**Mounting system DS**

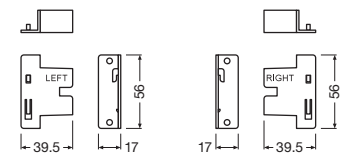
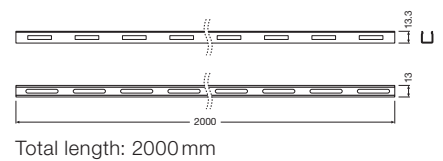

All figures in mm



**Matrix: Combination of LED drivers and LED modules**

	Outdoor 12V					Outdoor 24V						Indoor 24V DALI																		
	OT 15/220-240/12 P	OT 30/220-240/12 P	OT FIT 60/220-240/21 P	OT FIT 150/220-240/12 P	OT FIT 300/220-240/12 P	OT 20/220-240/24 DIM P	OT 20/220-240/24 P	OT 40/220-240/24 DIM P	OT 40/220-240/24 P	OT 60/220-240/24 DIM P	OT 60/220-240/24 P	OT 100/220-240/24 DIM P	OT 100/220-240/24 P	OT 130/220-240/24 DIM P	OT 130/220-240/24 P	OT 250/220-240/24 DIM P	OT 250/220-240/24 P	OTi DALI 50/220-240/24 1-4 CH	OTi DALI 50/220-240/24 TW	OTi DALI 80/220-240/24 1-4 CH	OTi DALI 80/220-240/24 TW	OTi DALI 160/220-240/24 1-2 CH	OTi DALI 160/220-240/24 TW	OTi DALI 100/220-240/24 1-4CH P	OTi DALI 210/220-240/24 1-4CH P	OTi BLE 80/220-240/24 1-4CH				
<b>BackLED®</b>																														
BA-L-CX G4	10	20	40	100	200																									
BA-MINI-S-CP G4	41	83	165	415	830																									
BA-MINI-M-CP G4	20	41	83	208	415																									
BA-XS-CP G4	50	100	200	500	1000																									
BA-S-CP G4	46	93	187	468	937																									
BA-S-CP RD G4	42	85	171	428	857																									
BA-S-PL GR G15	39	78	157	394	789																									
BA-S-PL BL G15	39	78	157	394	789																									
BA-M-CP G4	20	41	83	208	416																									
BA-M-HO-CP G4	12	25	50	125	250																									
BA-M-CP RD G4	25	50	100	250	500																									
BA M-CP BL G4																														
BA-L-PL G3	11	23	46	115	230																									
BA-XL-PL G3						9	18	27	45	59	113						22	22	36		72			45	95	36				
BA-DS-PL G3 (24V)						4	9	13	22	29	56						11		18		36			22	47	8				
BA-TW-PL G2*						***	***	***	***	***	***						10	10	16	16	33	33		20	43	16				
BA-RGBW-PL G2*						***	***	***	***	***	***						12		27					35	74	27				
<b>BoxLED®</b>																														
BX-XS-PL G3	11	23	46	115	230																									
BX-ECO-M-PL G3						6	12	19	32	41	80						16		25		51					67	25			
BX-M-PL G3						6	13	20	33	43	83						16		26		53					70	26			
BX-L-PL G3	2	5	10	25	50																									
BXI-L-PL G1						3	6	10	16	21	41						8		13		26					35	13			
BA-AR-G1 2700/3000K						2	4	6	11	14	27						5		8		17			11	23	8				
BA-AR-G1 4000K						2	4	6	11	15	29						5		9		18			11	24	9				
BA-AR-G1 TW**						***	***	***	***	***	***						-	2	-	4	-	9	-	-	-	4				

Please note: Max. one chain in series

\* Systems with BA-TW-PL G2 and BA-RGBW-PL G2 and 24V outdoor LED drivers must include an appropriate dimming device: OTi DALI DIM 1-4CH D 4062172166010, OT DMX RGBW DIM 4052899557949, OT BLE DIM 4052899557833

\*\* Only DT8/BLE TW compatible

\*\*\* An appropriate dimming device must be used and the compatible module quantity must be calculated according to the selected dimming device.

# BackLED® AREA and AREA TW



## BackLED® AREA for homogeneous illumination of flat light boxes

BackLED® AREA provides excellent light quality, especially in flat light boxes with a limited height of 40 mm or more. The module can be installed quickly and adapted to different shapes of luminaires. With the Tunable White versions, the atmosphere can be individually adjusted.

### Application areas

- Area lighting
- Light ceilings
- Hospitality, hotels, restaurants
- Museums, art galleries
- Individual and customized luminaires
- Backlighting shallow light boxes

### Benefits

- Great flexibility in uniformly backlit areas with different shapes
- Extremely low performance temperatures ( $T_p$ ), therefore large freedom in application on various surface materials!

## BackLED® AREA and AREA White

- Consistent white light: 3 SDCM
- Color temperature: 2,700 K, 3,000 K or 4,000 K (BackLED® AREA)
- Color rendering index (CRI): > 90
- Constant LED pitch even at board interconnections
- Cuttable single board for an exact fit in any installation
- Quick and easy mounting thanks to plastic holder provided in the box and also as separate accessory
- Easy wiring with push-in connectors
- Low energy consumption and less heat generation
- Optimal operation on OPTOTRONIC 24V<sub>DC</sub> and 24V<sub>DC</sub> dimmable power supplies

## BackLED® AREA TW

- 2,700 K – 6,500 K for dynamic white applications
- Product only compatible with DALI DT8 drivers (TW) or OSRAM BLE devices with OSRAM TW lamp profiles

### Standards

- CE

### Dimensions

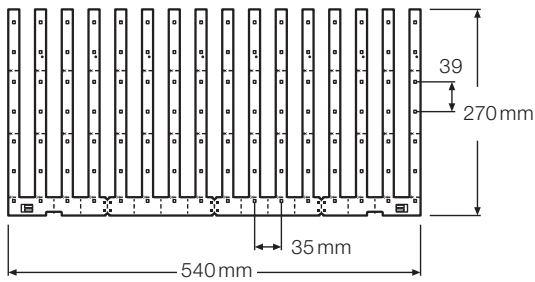

Number of LEDs per module = 112 (BackLED AREA)  
 Number of LEDs per module = 224 (BackLED AREA TW)

### Light distribution diagrams

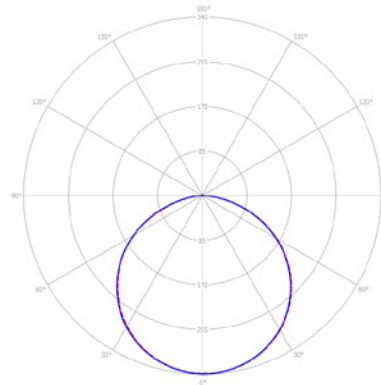

Beam angle 150°

cd/1000lm

- C0-C180
- C90-C270

### Electrical and output data

Nominal voltage	24 V
Reverse voltage protection up to	25 V
Temperature range in operation at T <sub>c</sub> point	-25...+55 °C
Storage temperature	-30...+80 °C

	BA-AR-G1 927	BA-AR-G1 930	BA-AR-G1 940	BA-AR-G1 TW**
Power per board [W]	9	9	8.6	17.6
Luminous efficacy [lm/W]	100	102	110	105
Luminous flux per board [lm]	900	920	950	925
Color temperature	2770 K	3066 K	4061 K	2770...6918 K
CRI	>90	>90	>90	>90

### BackLED® AREA

Modules	EAN	COLOR		V	W		K	$\lambda$	lm	IP	
<b>BackLED® AREA G1</b>											
BA-AR-G1 927	4062172124768	warm white	112	24	9.0*	2770	-	900*	IP00	16	
BA-AR-G1 930	4062172124782	warm white	112	24	9.0*	3066	-	920*	IP00	16	
BA-AR-G1 940	4062172124805	natural white	112	24	8.6*	4061	-	950*	IP00	16	
BA-AR-G1 965	TBA on demand										
<b>BackLED® AREA TW</b>											
BA-AR-G1 TW	4062172141659	WW, CW	224	24	17,6*	2770...6918	-	925**	IP00	16	
<b>BackLED® AREA holding bar</b>											
BA-BAR	4062172197168	-	-	-	-	-	-	-	-	-	16
<b>BA-BAR 16pcs KIT</b>											

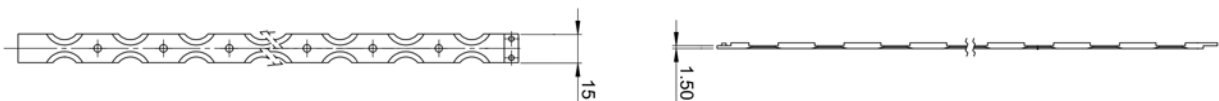

\* Due to the special conditions of the manufacturing processes of LED the typical data of technical parameters can only reflect statistical figures and do not necessarily correspond to the actual parameters of each single product which could differ from the typical data; Cutting between finger-bars changes functioning product power consumption; cutting of finger-bars doesn't change product power consumption. All values are tested at T<sub>a</sub> 25 °C  
 \*\* This product must be driven by a DALI DT8 power supply or OSRAM BLE devices with TW lamp profiles to keep lumen output flux steady across CCTs and the consumption among recommended limits. The declared maximum power value is the driver-perceived load for each LED board. However, due to DT8 PWM behavior of TW drivers or BLE lamp profiles at middle CCT (approx. 4,500 K), the actual consumption from the mains will be cut in half at the maximum output level (100 %).

## How to design a backlit area<sup>1</sup>

### Depth of the box

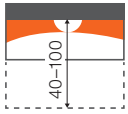

40–100 mm

### Choose the right module

BA-AR-G1

<sup>1</sup> The specified installation depths are only approximate values; the LED deSIGNer web tool provides detailed information

## Quickly fill large backlit areas with BackLED® AREA

To keep a constant pitch between LEDs, simply follow the instructions below. The BA-BAR 16pcs KIT accessory (provided with the product and also available as a separate accessory) will help separating the boards by 20 mm from side to side. No free space is necessary on the top and bottom sides, so no measurements need to be taken before installation!



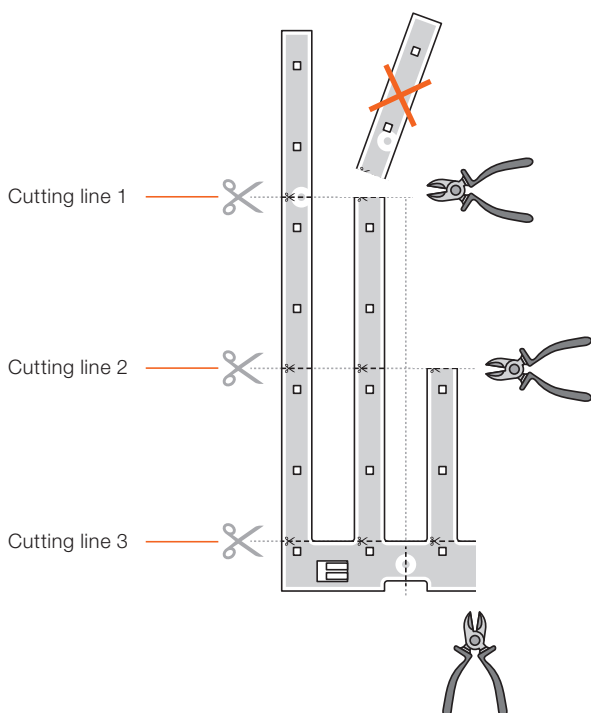

All boards can be cut by means of nippers on the marked cutting lines.

The BackLED® AREA LED board is designed to be split into four re-usable separate smaller boards, to be used where small areas of the luminaire are left uncovered by entire boards. Several soldering pads are provided on the product to use cut parts.

Boards can be also cut between each finger-line. In this case and under certain cutting conditions, remaining boards may not be re-usable as soldering pads may not be available for further connections.

Cutting lines 1 and 2 will allow remaining LEDs connected to the main board to continue working. Cut-offs can't be re-connected to the main board and must not be re-used.

Boards with finger-lines cut on cutting lines 1 and/or 2 will keep power consumption unaltered.

Finger-lines cut at line 3 will stop the last remaining LED on the board from working.

Cut finger-line leftovers cannot be reused and must be disposed of according to local regulations.

# Bringing light boxes to life: BoxLED® Plus

Even, powerful and efficient side lighting in high quality –  
for high-precision light distribution



BoxLED® Plus\* modules were developed for side injection into single-sided and double-sided light boxes which are painted or coated matt white inside, while elliptical optics provide homogeneous light distribution in the interior.

Depending on the size of the light boxes and the required amount of light, the modules can be placed on one side, on two sides or on all four sides (see the illustrations below).

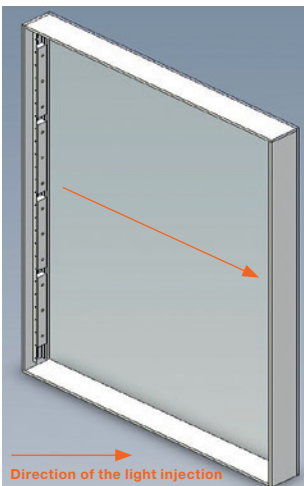

Single-sided light injection  
For low luminance

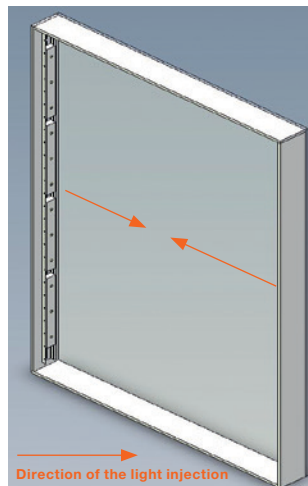

Double-sided light injection  
For medium luminance

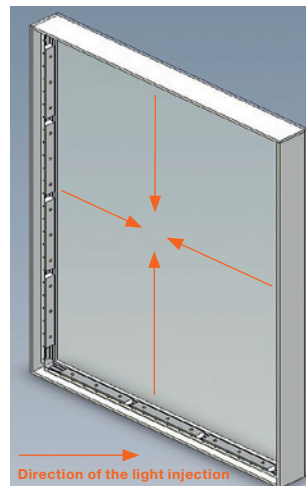

Four-sided light injection  
For high luminance

More details:  
[www.osram.com/download](http://www.osram.com/download)



BoxLED® M Plus G3

#### Features and benefits

- Even illumination through optimized elliptical lenses
- Quick and easy mounting with screws or snap-in into a mounting profile
- Outstanding module efficiency
- Very long lifetime

#### Application areas

- Signage and illuminated advertising
- Backlighting of single-sided and double-sided light boxes
- Long-term outdoor application only in closed light boxes



\* All products of the BoxLED® Plus family comply with energy efficiency class A or higher

# BoxLED® Plus

## Light distribution diagrams

**BoxLED® XS PL G3**

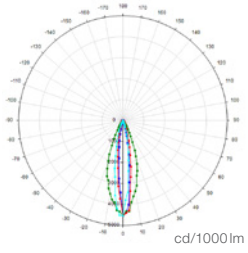

- C0-C180, 15.5°
- C90-C270, 34°
- C45-C225, 20°
- C135-C315, 12.3°

**BoxLED® M PL G3**

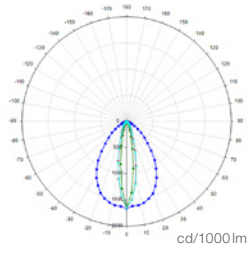

- C0-C180, 74°
- C90-C270, 16°
- C45-C225, 24°
- C135-C315, 24°

**BoxLED® L PL G3**

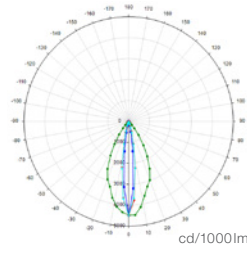

- C0-C180, 12°
- C90-C270, 52°
- C45-C225, 16°
- C135-C315, 16°

**BoxLED® ECO M PL G3**

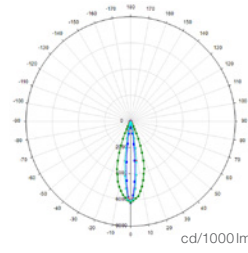

- C0-C180, 12°
- C90-C270, 36°
- C45-C225, 16°
- C135-C315, 16°



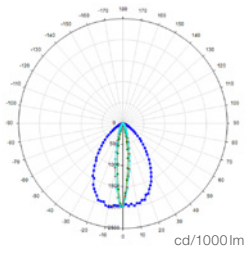

**BoxLED® Indoor L PL G1**



- C0-C180, 74°
- C90-C270, 13°
- C45-C225, 18°
- C135-C315, 18°



## BoxLED® Plus

Modules	EAN	 COLOR	No. of modules		V	W <sup>1)</sup>		K	lm <sup>1)</sup>	IP	
<b>BoxLED® XS Plus G3</b>											
BX-XS-PL-865	4052899989696	white	32	3	12	42 (1.3)	12 x 34	6000	4320 (135)	IP66&IP68	5
BX-XS-PL-840	4052899989719	white	32	3	12	42 (1.3)	12 x 34	4000	4320 (135)	IP66&IP68	5
BX-XS-PL-830	4052899989733	white	32	3	12	42 (1.3)	12 x 34	3000	4320 (135)	IP66&IP68	5
<b>BoxLED® ECO M Plus G3</b>											
BX-ECO-M-PL 865	4052899946996	white	32	6	24	99.8 (3.1)	12 x 60	6500	10094 (315)	IP66	5
BX-ECO-M-PL 840	4052899947016	white	32	6	24	99.8 (3.1)	12 x 60	4000	10474 (327)	IP66	5
BX-ECO-M-PL 830	4052899947030	white	32	6	24	99.8 (3.1)	12 x 60	3000	10474 (327)	IP66	5
<b>BoxLED® M Plus G3</b>											
BX-M-PL 865	40528999493155	white	32	12	24	96 (3.0)	12 x 70	6500	10200 (320)	IP66&IP68	5
BX-M-PL 840	40528999493179	white	32	12	24	96 (3.0)	12 x 70	4000	10200 (320)	IP66&IP68	5
BX-M-PL 830	40528999493193	white	32	12	24	96 (3.0)	12 x 70	3000	9760 (305)	IP66&IP68	5
<b>BoxLED® L Plus G3</b>											
BX-L-PL 765	4052899990081	white	10	3	12	60 (6)	11 x 53.5	6500	6200 (620)	IP66&IP68	5
BX-L-PL 840	4052899990760	white	10	3	12	60 (6)	11 x 53.5	4000	5300 (530)	IP66&IP68	5
<b>BoxLED® Indoor L Plus G1</b>											
BXI-L-PL 865	4052899518193	white	16	24	24	96 (6.0)	12 x 70	6500	10200 (638)	IP20	5
BXI-L-PL 840	4052899518216	white	16	24	24	96 (6.0)	12 x 70	4000	10200 (638)	IP20	5
BXI-L-PL 830	4052899518230	white	16	24	24	96 (6.0)	12 x 70	3000	9600 (600)	IP20	5

1) Chain (module)

# Reliable all-rounders: OPTOTRONIC® LED drivers

OPTOTRONIC® LED drivers are perfectly matched to the BackLED® and BoxLED® modules in order to achieve maximum efficiency, reliability and economy





Together with the LED modules, the LED drivers form a perfect entity, which ensures long-term, safe operation. In order to fulfill the heavy-duty requirements that characterize outdoor applications, the drivers meet high quality standards for best possible weather resistance and performance. Especially in indoor applications, our versatile LED drivers provide multiple output characteristics for color control and Tunable White. Thanks to their high reliability, efficiency and flexibility, the entire product portfolio opens up a wide range of applications and is the best choice for demanding conditions.

#### Features and benefits

- Broad range of application areas thanks to output powers of up to 300 W
- Very high efficiency and reliability
- High ingress protection rating (up to IP66 and IP67)
- Wide temperature ranges for outdoor applications
- High overvoltage protection: up to 6 kV (L-N)/8 kV (L/N-PE)
- SPS – Smart Power Supply

#### Application areas

- Installations in indoor and outdoor areas
- Ideal for mounting in tight spaces

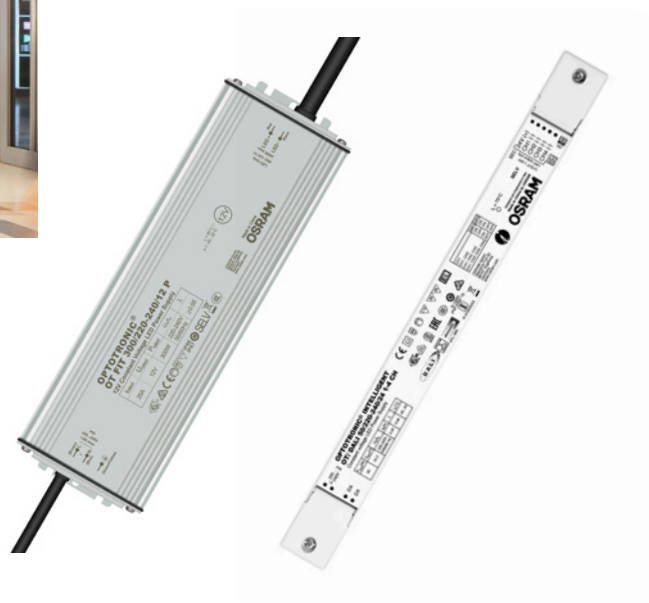

## Outdoor LED drivers OPTOTRONIC® 12 and 24 V PROTECTED



### Features and benefits

- Very high efficiency and reliability
- High ingress protection rating
- High surge protection

### Application areas

- Signage
- Facades
- Wellness areas

These LED drivers offer long-lasting durability even in severe weather conditions. Characterized by their robust design, the drivers meet the highest requirements regarding exposure to liquids or salt spray and high variations in temperature. The 12-V portfolio ranges from 15W to 300W, the 24-V portfolio from 20W to 300W.

### Outdoor LED drivers

Product reference	EAN	V <sub>OUT</sub>	IP	W	λ	Overload protection	Dimensions L x W x H [mm]	
OTi DALI 100/220-240/24 1-4CH P	4062172119191	24	66/67	100	> 0.95	Automatic, reversible	237 x 69 x 37	NEW
OTi DALI 210/220-240/24 1-4CH P	4062172032087	24	66/67	210	> 0.95	Automatic, reversible	330 x 69 x 37	
OT 20/220-240/24 DIM P	4052899545809	24	66/67	20	0.95	Automatic, reversible	188 x 43 x 25	
OT 40/220-240/24 DIM P	4052899545823	24	66/67	40	0.95	Automatic, reversible	208 x 43 x 26	
OT 60/220-240/24 DIM P	4052899545847	24	66/67	60	0.95	Automatic, reversible	208 x 43 x 26	
OT 100/220-240/24 DIM P	4052899545861	24	66/67	100	0.95	Automatic, reversible	240 x 50 x 34	
OT 130/220-240/24 DIM P	4052899545885	24	66/67	130	0.95	Automatic, reversible	220 x 63 x 37	
OT 250/220-240/24 DIM P	4052899545908	24	66/67	250	0.95	Automatic, reversible	265 x 68 x 39.5	
OT 20/220-240/24 P	4052899545922	24	66/67	20	0.95	Automatic, reversible	188 x 43 x 25	
OT 40/220-240/24 P	4052899545946	24	66/67	40	0.95	Automatic, reversible	208 x 43 x 26	
OT 60/220-240/24 P	4052899545960	24	66/67	60	0.95	Automatic, reversible	208 x 43 x 26	
OT 100/220-240/24 P	4052899545984	24	66/67	100	0.95	Automatic, reversible	240 x 50 x 34	
OT 130/220-240/24 P	4052899546004	24	66/67	130	0.95	Automatic, reversible	220 x 63 x 37	
OT 250/220-240/24 P	4052899546028	24	66/67	250	0.95	Automatic, reversible	265 x 68 x 39.5	
OT FIT 80/220-240/24 P	4062172085465	24	66/67	80	0.95	Automatic, reversible	167 x 53 x 31.5	Coming soon
OT FIT 150/220-240/24 P	4062172085601	24	66/67	150	0.95	Automatic, reversible	202 x 53 x 31.5	
OT FIT 200/220-240/24 P	4062172085649	24	66/67	150	0.95	Automatic, reversible	217 x 53 x 31.5	
OT FIT 300/220-240/24 P	4062172085687	24	66/67	150	0.95	Automatic, reversible	264 x 68 x 39.5	
OT 15/220-240/12 P	4052899905559	12	67	15	> 0.5	Automatic, reversible	237 x 20 x 22	
OT 30/220-240/12 P	4052899905542	12	67	30	> 0.95	Automatic, reversible	220 x 40 x 22	
OT FIT 60/220-240/12 P	4062172133487	12	66/67	60	0.95	Automatic, reversible	167 x 53 x 31.5	NEW
OT FIT 150/220-240/12 P	4062172133500	12	66/67	150	0.95	Automatic, reversible	202 x 53 x 31.5	NEW
OT FIT 300/220-240/12 P	4062172133548	12	66/67	300	0.95	Automatic, reversible	266 x 83 x 39.5	NEW

## Indoor LED drivers OPTOTRONIC® 24 V ON/OFF, DALI and Bluetooth

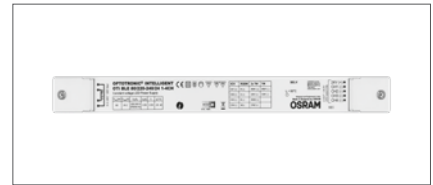

### OPTOTRONIC® 24V ON/OFF

The OT SLIM drivers have the slimmest cross-section available on the market. The LED drivers come with different powers to ensure that a wide range in installation needs can be fulfilled. With a lifetime of up to 50,000 hours and an IP20 protection, the product family can be used in many indoor applications where narrow spaces limit room for LED driver placement.

#### Features and benefits

- Wide operating temperature range: -20...+50 °C
- Very stable output power
- Automatic reversible short-circuit, overload and overtemperature protection
- Independent installation possible

#### Application areas

- Cove lighting, handrails, light boxes
- Compact luminaires, tracks
- Indoor signage
- Suitable for indoor installations

### OPTOTRONIC® 24V DALI

Providing high-performance LED power supply, these indoor LED drivers are best suited for architectural lighting and interior design. This family of 24V, IP20 LED drivers includes dimmable OPTOTRONIC® OTi DALI LED drivers with either 2-channel, 4-channel, or Tunable White functionality.

#### Features and benefits

- 1-4CH and Tunable white in DALI-2
- Touch DIM® functionality
- Lamp failure detection
- DC capability and emergency mode

#### Application areas

- Cove lighting
- Illuminated ceilings
- Wall washers
- Handrails

### OPTOTRONIC® 24V Bluetooth

The OTi BLE 80/220-240 1-4 CH enables wireless bluetooth mesh control of white, Tunable (Warm) White, DIM to Warm, RGB and RGBW LED modules via the integrated lighting control system CASAMBI. Some other features include the dimming range of 0.4 – 100 % and the possibility to install a connection with wireless sensors and wireless smart switches and smart switches.

#### Features and benefits

- 80 W/24 V LED driver, 1–4 channels
- Power metering on the app interface
- Lighting wireless Bluetooth Mesh network, up to 127 devices
- Different light profiles to customize the application
- 2 KHz PWM control unit

#### Application areas

- Shops and retail
- Hospitality: Hotels and restaurants
- Museums
- Residential buildings

## Indoor LED drivers

Product reference		V <sub>out</sub>	IP	W	λ	Overload protection	Dimensions L x W x H [mm]	
OT SLIM 30/220-240/24	4062172135733	24	20	30	> 0.95	Automatic, reversible	270 x 30 x 17.5	NEW
OT SLIM 60/220-240/24	4062172135856	24	20	60	> 0.95	Automatic, reversible	338 x 30 x 17.5	NEW
OT SLIM 100/220-240/24	4062172135870	24	20	100	> 0.95	Automatic, reversible	374 x 30 x 18.5	NEW
OT SLIM 160/220-240/24	4062172135894	24	20	160	> 0.95	Automatic, reversible	404 x 30 x 21.5	NEW
OT SLIM 250/220-240/24	4062172135917	24	20	250	> 0.95	Automatic, reversible	343 x 60 x 31	NEW
OTi DALI 50/220-240/24 1-4 CH	4052899452916	24	20	50	> 0.95	Automatic, reversible	345 x 32 x 22	
OTi DALI 50/220-240/24 TW	4052899490772	24	20	50	0.98	Automatic, reversible	345 x 32 x 22	
OTi DALI 80/220-240/24 1-4 CH	4052899452893	24	20	80	> 0.95	Automatic, reversible	345 x 32 x 22	
OTi DALI 80/220-240/24 TW	4052899490758	24	20	80	0.98	Automatic, reversible	345 x 32 x 22	
OTi DALI 160/220-240/24 1-2 CH	4052899986305	24	20	160	0.99	Automatic, reversible	300 x 50 x 35	
OTi DALI 160/220-240/24 TW	4052899986305	24	20	160	0.99	Automatic, reversible	300 x 50 x 35	
OTi BLE 80/220-240/24 1-4CH*	4062172046558	24	20	80	0.98	Automatic, reversible	345 x 32 x 22	

\* Download Casambi app from App Store or Google Play. For the correct functioning of the Casambi app, refer to the Casambi website: <http://www.casambi.com>. The Casambi App is provided to you by Casambi. OSRAM shall have no liability for the Casambi app and does not make any representations, express or implied, about the availability and/or performance of the Casambi app. The Casambi cloud services are provided to you by Casambi. OSRAM shall have no liability for the Casambi cloud services and does not make any representations, express or implied, about the availability and/or performance of the Casambi cloud services. OSRAM shall have no liability for and does not make any representations, express or implied, about the connectivity of Casambi ready products of OSRAM with any other Casambi ready products. Guarantee conditions available <https://www.osram.com/cb/services/guarantees/multilevel-guarantees/index.jsp>

# Our services: Fast response and long-term support

In order to ensure the sustainable success of our customers, OSRAM offers practical support, direct assistance and a long-term product policy

We know about the challenges that you face on a daily basis and therefore adapt our services precisely to your requirements. In combination with the know-how of our experts, this practical experience is the foundation of successful and future-proof projects.

### Safety with OSRAM 5-year guarantee\*

Based on the high quality of our products in terms of reliability, workmanship and functionality, we give you a guarantee of up to 5 years on all LED modules and drivers as well as LMS components. No registration is required for this. This ensures that you remain on the safe side and that you can rely on OSRAM as a partner who offers you state-of-the-art lighting systems.

\*Terms of guarantee can be found at [www.osram.com/guarantee](http://www.osram.com/guarantee)

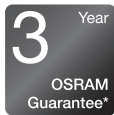

### Perfect planning with the OSRAM LED deSIGNer

Find the best overall package with the OSRAM LED deSIGNer, easily and quickly, and even for very demanding lighting projects. After entering only a few data, the free online software recommends the required amount of LED modules and LED drivers that enable homogeneous backlighting within the application.

#### Further benefits of the LED deSIGNer

- Luminance calculation for BackLED® products (S, M, L, XL Plus and M HO)
- Selection of more than 100 acrylic glasses and more than 50 different PVC/textiles
- Can be used to create sales quotations

Start your planning now at <https://www.osram.com/ds/flexible-lighting-systems/leddesigner-backlight.jsp>



Do your layout in 4 steps or your full-system quotation in only 8 steps with our LED deSIGNer free online tool.

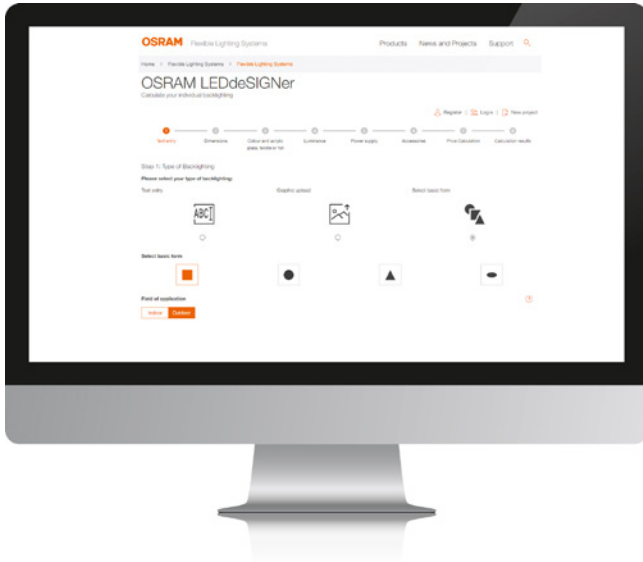

Select your scope of layouting: lettering, basic shapes, special upload for custom shapes.

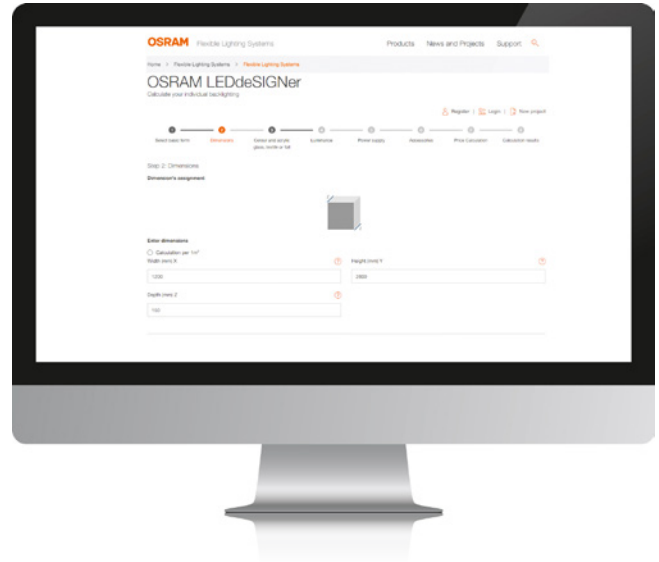

Enter the dimensions according to your project.

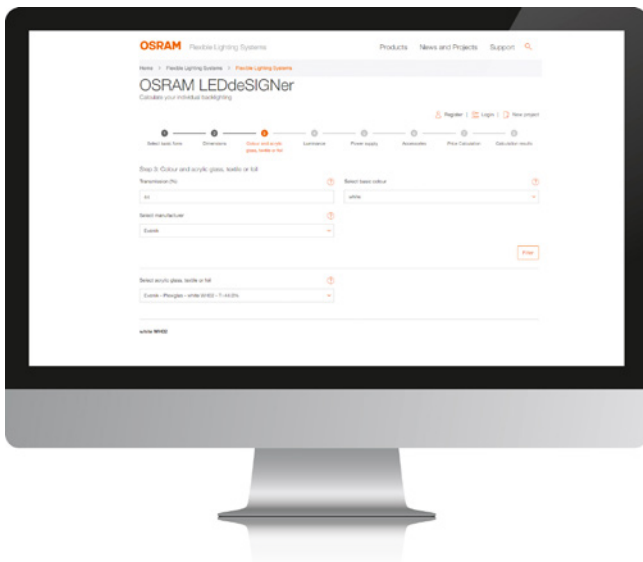

Select the diffusive material for your project from the existing ones on the list, or simply enter the material properties.



Enter the luminance level that you want to achieve and the module you want to use if the suggested one is not your desired one.

Start the calculation and your layouting dimensions and details will be displayed!



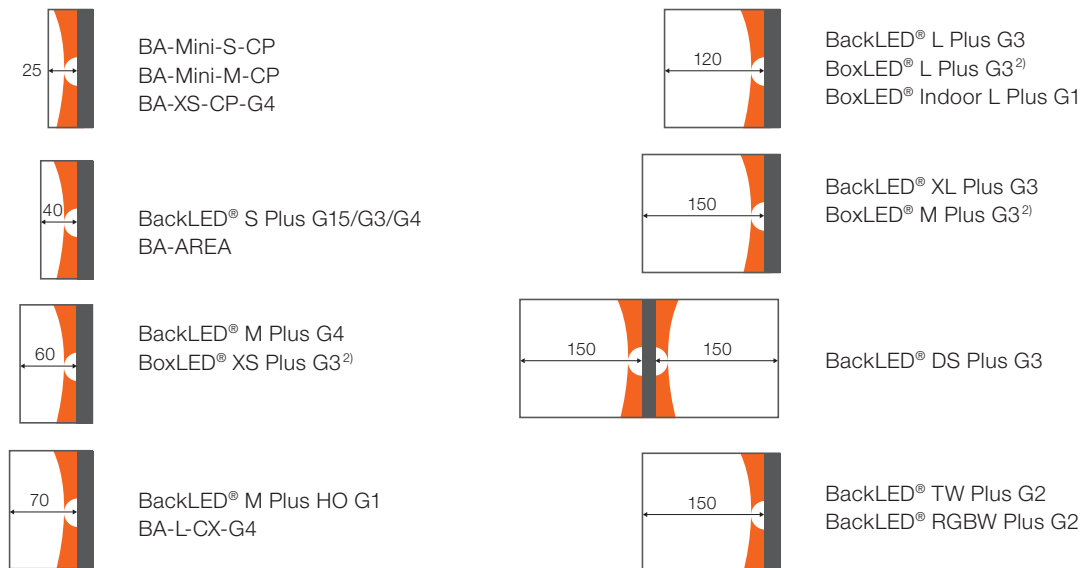







**Minimum suggested mounting depths in mm<sup>1)</sup>**



1) The specified installation depths are only approximate values; the LED deSIGNer provides detailed information

2) The given installation depth is only valid if the modules are installed in the middle of the box; for more information, please refer to the technical application guide "BackLED® and BoxLED® portfolio"

**Symbols**

 COLOR	Color	 <b>lm</b>	Luminous flux in lm
	No. of LEDs per module		Standard pack in pcs.
 <b>V</b>	Voltage in V	 <b>V<sub>OUT</sub></b>	Output voltage in V
 <b>W</b>	Power in W	 <b>IP</b>	Type of protection
	Beam angle in °		Power factor
 <b>K</b>	Color temperature in K		



# Do you need professional support?

Our experienced lighting professionals are at your service to consult you in the planning and successful implementation of your projects.

For technical questions, please do not hesitate to send an e-mail to the following address:

[signage-support@osram.com](mailto:signage-support@osram.com)



You want to contact us?  
Here you can find our worldwide sales contacts

[https://www.osram.com/ds/contact\\_2.jsp](https://www.osram.com/ds/contact_2.jsp)



Need more support? As a registered customer,  
you can contact our experts by e-mail

[support-ds@osram.com](mailto:support-ds@osram.com)



Not a registered customer?  
Please use our contact form

<https://www.osram.com/apps/cbcontact/contacts/add>



OSRAM GmbH

Headquarters Germany:

Marcel-Breuer-Strasse 6  
80807 Munich, Germany  
Phone +49 89 6213-0  
Fax +49 89 6213-2020  
[www.osram.com](http://www.osram.com)

**OSRAM**